





Innovation in Packaging & Labels

# INSTOCK 3









 Order by 3pm

 Next day delivery on all stock items

 Join our mailing list

Receive emails with new products, bulk deals and offers.

Join now at [bonustrading.co.uk](http://bonustrading.co.uk)

	<b>Tapes</b>	<b>6</b>
	<b>Postal Products</b>	<b>17</b>
	<b>Cartons &amp; Boxes</b>	<b>22</b>
	<b>Protective Products</b>	<b>26</b>
	<b>Packaging</b>	<b>38</b>
	<b>Strapping</b>	<b>44</b>
	<b>Pallet Wrap</b>	<b>49</b>
	<b>Equipment</b>	<b>54</b>
	<b>Labels &amp; Printers</b>	<b>86</b>

# OUR SERVICES

In addition to our vast product range and bespoke manufacturing, we provide a range of services to help efficiently manage your packaging stock and supply

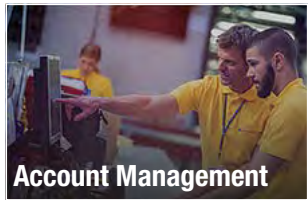

**Account Management**

Our team of dedicated Account Managers have in-depth experience of our full product range and the bespoke requirements of our customers. They will be able to assist with any enquiry you may have, offering expert advice and the best solutions for all your packaging needs.



**Inventory Management**

We specialise in the storage and distribution of packaging, labels and supplies to our clients, making sure the flow of products from our 30,000 sq. ft. of warehouse space arrive on time, when you need them. Inventory management is a fundamental part of a thriving business. We can procure, stock hold, and organise the logistics for all of your packaging needs.



**Packaging Assessment**

If you are looking for the correct packaging to fit your products we can help you. We have the experience and capability, and we are always looking for new and innovative ways to package and process the array of products our customers deliver. The better and more efficiently your goods are packaged, wrapped and protected, the more you can add to your bottom line.



# INSTOCK 3

Dear Customer

Welcome to IN STOCK 3, full of innovative, quality, packaging machinery and products, all ready for immediate despatch across the UK and Europe.

Bonus Trading offers great value and an unbeatable service, backed up by an extensive stock range of products. With over 10 years experience, you can count on us for all your packaging and labelling solutions.

**Don't forget to ask for your free gift when you order**

*See all your complimentary gift options inside the back of this brochure.*

*The Bonus Team*

## Mission Statement

“ Our mission is to deliver the ultimate value of a flexible service package to benefit all selectors and clientele, by providing consistent and sustained quality through our professional packaging and labelling solutions. ”

Tapes	6
Postal Products	17
Cartons & Boxes	22
Protective Products	26
Packaging	38
Strapping	44
Pallet Wrap	49
Grip Film	52
Equipment	54
Tape Dispensers	54
Void Fill Disp'ers	62
Stapling	65
Gluing	68
Strapping Equip.	70
Shrinking Equip.	75
Machinery	76
Cutters & Knives	80
Washroom & PPE	83
Labels & Printers	86
Gifts	102



Next day delivery on all stock items

**BRGS**

Storage and Distribution

CERTIFICATED

**BRGS ACCREDITATION AA CERTIFIED**

Bonus Trading has been awarded the highest grade BRGS certification in the Storage and Distribution sector. We are listed in the BRGS Global Standards Directory which can be searched online.

Bonus Trading is a trusted adviser and service provider



grip<sup>SYSTEMS</sup>

## Grip Twist-Lock Dispenser

- A more efficient way to wrap pallets
- Fast and secure locking system
- Magnetic, for convenient off-floor storage

Item Code 1616012



ALL NEW  
MAGNETISED  
DISPENSER



### Super fast roll change system

The unique combination of the notched film roll and Twist-Lock retention mechanism allows you to rapidly replace used rolls in seconds.



### Secure non-slip core retention

The **grip®film** robust core is designed to interface seamlessly with the **grip®** dispenser.



### Set the perfect tension

Once located... simply twist the Twist-Lock knob.



### Comfortable ergonomic grip

Manufactured from soft, tactile and easy-grip synthetic material to enhance feel and control.



### Lightweight

Manufactured from soft, tactile and easy-grip synthetic material to enhance feel and control.

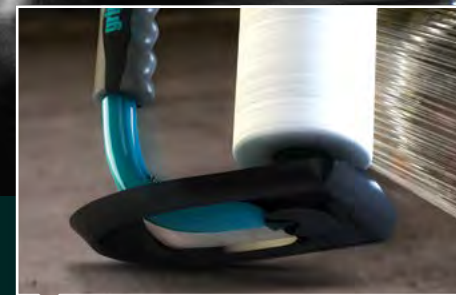

### Extra tough skid plate

The **grip®** skid-plate lets you get low to grab those corners and doubles up as a handy base.



### Handy storage

The **grip®** hook is easily fixed to racking or a wall. A great alternative storage solution for your dispenser.



For the full range of Grip film and products see page 52

**ZeroTape®**

- Tape for use with ZeroTape dispensers
- Unit is per roll

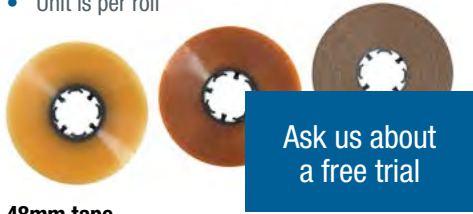

Ask us about a free trial

**48mm tape**

Item Code	Length	Type	Colour	Min. Order
0616021	150m	Solvent	Clear	36 rolls
0616022	150m	Solvent	Brown	36 rolls
0616023	150m	High Tack Acrylic	Clear	36 rolls
0616024	150m	High Tack Acrylic	Brown	36 rolls
0616027	70m	Paper / Hotmelt	Brown	36 rolls

**72mm tape**

0616028	100m	High Tack Acrylic	Clear	24 rolls
---------	------	-------------------	-------	----------

**ZeroTape® Bundles**

- Bulk buy tape starter bundles - 50mm width
- With free ZeroTape First dispensers



Ask us about more bundles

Item Code	Rolls	Colour	Dispensers	Unit
0616014	36	Clear	1 First	Each
0616013	36	Brown	1 First	Each
0616007	108	Clear	2 First	Each
0616008	108	Brown	2 First	Each
0616009	180	Clear	3 First	Each
0616010	180	Brown	3 First	Each
0616011	360	Clear	5 First	Each
0616012	360	Brown	5 First	Each



See **ZeroTape®** First & Classic dispensers and accessories on page 56.

72mm dispensers and tape now available.



**ZEROTAPE**  
THE ERGONOMIC TAPE SYSTEM



**Performance Boosting**

Fewer roll changes due to over 2 times the tape length of many standard tapes. Fast and safe blade changes.

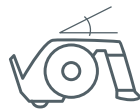

**Comfortable**

Reduced operating angle results in less wrist strain. Easy and smooth unwinding. Ventilated handle for better grip.



**Sustainable**

Longer rolls means less packaging waste, minimising your carbon footprint.

**e-tape® 50mm width**

- Ideal for sealing cartons and boxes
- Extra long rolls up to 2.33 times more
- e-tape 2 (Solvent adhesive)
- e-tape 2 SVR (Hotmelt adhesive)
- e-tape+ (Acrylic adhesive)



Ask about custom printed **e-tape®** See page 16

Item Code	Length	Type	Colour	Unit	Min. Order
0216016	150m	e-tape 2 (Solvent)	Brown	Roll	36 rolls
0216017	150m	e-tape 2 (Solvent)	Clear	Roll	36 rolls
0216020	150m	e-tape 2 SVR (Hotmelt)	Brown	Roll	36 rolls
0216021	150m	e-tape 2 SVR (Hotmelt)	Clear	Roll	36 rolls
0216022	150m	e-tape+ (Acrylic)	Brown	Roll	36 rolls
0216023	150m	e-tape+ (Acrylic)	Clear	Roll	36 rolls

**e-tape® 75mm width**

- Extra wide 3 inch tape
- 100 metre length rolls



Item Code	Length	Type	Colour	Unit	Min. Order
0216038	100m	Solvent	Brown	Roll	24 rolls
0216039	100m	Solvent	Clear	Roll	24 rolls
0216100	100m	Acrylic	Clear	Roll	24 rolls
0216101	100m	Acrylic	Brown	Roll	24 rolls

**Recycled PET Tapes 48mm width**

- 48mm rPET adhesive tape rolls
- Made from 85% recycled plastic consumer waste
- e-tape and ZeroTape options



Made with 85% recycled plastic

Item Code	Length	Type	Colour	Unit	Min. Order
0216128	150m	Hotmelt	Clear	Roll	36 rolls
0216129	150m	Hotmelt	Brown	Roll	36 rolls

**ZEROTAPE**

Item Code	Length	Type	Colour	Unit	Min. Order
0616033	180m	Hotmelt	Clear	Roll	36 rolls

**Vinyl Tape**

- Ideal for sealing cartons
- 66 metre length rolls



Item Code	Width	Type	Colour	Unit	Min. Order
0116024	25mm	Solvent	Buff	Roll	72 rolls
0116044	25mm	Solvent	Clear	Roll	72 rolls
0116101	25mm	Solvent	Red	Roll	72 rolls
0116025	50mm	Solvent	Buff	Roll	36 rolls
0116045	50mm	Solvent	Clear	Roll	36 rolls
0116062	50mm	Solvent	Green	Roll	36 rolls
0116016	50mm	Solvent	Blue	Roll	36 rolls
0116111	50mm	Solvent	White	Roll	36 rolls

**Crossweave Tape**

- Extra strong, tear resistant tape
- 50 metre length rolls



Item Code	Width	Colour	Unit	Min. Order
0116146	12mm	Clear	Per roll	72 rolls
0116147	19mm	Clear	Per roll	48 rolls
0116148	25mm	Clear	Per roll	36 rolls
0116149	50mm	Clear	Per roll	36 rolls
0116150	75mm	Clear	Per roll	24 rolls

**Polypropylene Tape**

- Sized for use with many standard tape dispensers
- 50mm suits standard pistol grip dispensers
- Temperature resistant up to 50°C
- Perfect for the majority of lightweight packaging
- 66 metre length rolls



Item Code	Width	Type	Colour	Unit	Min. Order
0116038	12mm	Acrylic	Clear	Roll	144 rolls
0116030	25mm	Easy Tear	Clear	Roll	72 rolls
0116423	25mm	Acrylic	Clear	Roll	72 rolls
0116408	25mm	Hotmelt	Clear	Roll	72 rolls
0116003	50mm	Acrylic	Buff	Roll	36 rolls
0116006	50mm	Hotmelt	Buff	Roll	36 rolls
0116013	50mm	L/Noise	Buff	Roll	36 rolls
0116022	50mm	Solvent	Buff	Roll	36 rolls
0116028	50mm	Acrylic	Clear	Roll	36 rolls
0116031	50mm	Hotmelt	Clear	Roll	36 rolls
0116041	50mm	Solvent	Clear	Roll	36 rolls

Show your brand on your tape.  
Ask us about bespoke custom printing. See page 16

**Masking Tape**

- High quality. Leaves no residue
- 50 metre length rolls



Item Code	Width	Colour	Unit	Min. Order
0116160	12mm	Off-white	Per roll	144 rolls
0116161	19mm	Off-white	Per roll	96 rolls
0116162	25mm	Off-white	Per roll	72 rolls
0116163	38mm	Off-white	Per roll	48 rolls
0116164	50mm	Off-white	Per roll	36 rolls
0116166	75mm	Off-white	Per roll	24 rolls

**Polypropylene Machine Tape**

- For Auto and Semi-auto Case Tapers
- 990 metre length rolls



For case tapers see page 79

Item Code	Width	Colour	Unit	Min. Order
0116034	48mm	Clear	Per roll	6 rolls
0116035	48mm	Clear	Per roll	6 rolls
0116019	48mm	Buff	Per roll	6 rolls
0116099	48mm	Red	Per roll	6 rolls

**Polypropylene Tape Colours**

- Brighter coloured polyprop tapes
- Hotmelt adhesive



Item Code	Width	Type	Colour	Unit	Min. Order
0116004	50mm	Hotmelt	Blue	Roll	36 rolls
0116058	50mm	Hotmelt	Green	Roll	36 rolls
0116097	50mm	Hotmelt	Red	Roll	36 rolls
0116115	50mm	Hotmelt	Yellow	Roll	36 rolls

**BULK BUY AND SAVE**

**BULK ORDERING OPTIONS ON MOST PRODUCTS**

For updates on products and offers, join our mailing list at [bonustrading.co.uk](http://bonustrading.co.uk)

**Printed Message Tape**

- Message printed red on white
- 66 metre length rolls



Item Code	Width	Printed Message	Type	Unit	Min. Order
0316001	50mm	Awaiting Inspection	Polyprop	Per roll	36 rolls
0316002	50mm	Contents Checked. Security Sealed	Polyprop	Per roll	36 rolls
0316003	50mm	Caution	Polyprop	Per roll	36 rolls
0316006	50mm	Fragile	Polyprop	Per roll	36 rolls
0316007	50mm	Fragile	Vinyl	Per roll	36 rolls
0316008	50mm	Glass. Handle with Care	Polyprop	Per roll	36 rolls
0316009	50mm	Handle with Care	Polyprop	Per roll	36 rolls
0316010	50mm	QC Accepted	Polyprop	Per roll	36 rolls
0316011	50mm	QC Hold	Polyprop	Per roll	36 rolls
0316012	50mm	QC Inspected	Polyprop	Per roll	36 rolls
0316013	50mm	QC Rejected	Polyprop	Per roll	36 rolls
0316014	50mm	Quarantine	Polyprop	Per roll	36 rolls
0316015	50mm	Reject	Polyprop	Per roll	36 rolls
0316018	50mm	Security Seal	Polyprop	Per roll	36 rolls
0316020	50mm	This Way Up	Polyprop	Per roll	36 rolls

**ASK US ABOUT BULK BUY OPTIONS**

**Floor Marking Tape**

- Superior grade of PVC
- 33 metre length rolls



Item Code	Width	Colour	Unit
0416004	50mm	Blue	Per roll
0416005	50mm	Black	Per roll
0416006	50mm	Green	Per roll
0416007	50mm	Red	Per roll
0416008	50mm	White	Per roll
0416009	50mm	Yellow	Per roll
0416016	50mm	Orange	Per roll
0416010	75mm	Green	Per roll
0416011	75mm	Red	Per roll
0416012	75mm	White	Per roll
0416013	75mm	Yellow	Per roll

**Hazard Warning Tape**

- 33 metre length rolls



Item Code	Width	Colour	Unit
0416001	50mm	Green/White	Per roll
0416002	50mm	Red/White	Per roll
0416003	50mm	Yellow/Black	Per roll

**BULK BUY SAVINGS AVAILABLE**



Item Code	Info
0416014	Floor Tape Applicator

 **Join our mailing list**

Receive emails with new products, bulk deals and offers.

Join now at [bonustrading.co.uk](http://bonustrading.co.uk)

 **Order by 3pm**

 **Next day delivery on all stock items**

**Tamper Evident Tape**

- Protect your Valuable goods in transit
- Shows “Open Void” once tape has been removed
- Tape cannot be reused



See more security tapes and seals on our website



Item Code	Width	Length	Colour	Unit	Min. Order
0116203	48mm	50m	Blue	Per roll	48 rolls
0116204	48mm	50m	Red	Per roll	48 rolls

**Pouch Tape**

- Printed with “DOCUMENTS ENCLOSED”
- Roll size: 150mm x 66m
- 330 pouches per roll



Item Code	Size (WxL)	Unit	Min. Order
3416004	50mm x 66m	Per roll	12 rolls

**Low Tack Protection Tape**

- Easy to apply
- Easily removed when protection no longer required
- Bespoke sizes and thicknesses available on request

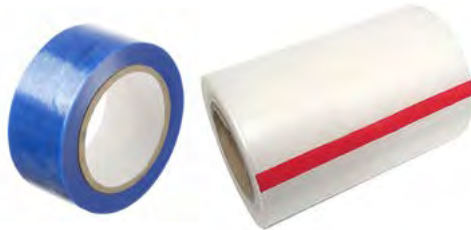

Item Code	Size (WxL)	Colour	Unit
4016374	25mm x 100m	Blue	Per roll
4016375	50mm x 100m	Blue	Per roll
4016376	75mm x 100m	Blue	Per roll
4016377	100mm x 100m	Blue	Per roll
0116439	250mm x 100m	Clear	Per roll
4016343	750mm x 100m	Blue	Per roll
4016345	600mm x 100m	Blue	Per roll
4016380	1000mm x 100m	Blue	Per roll

**Self Adhesive Kraft Tape Standard Core**

- Recyclable tape



Item Code	Width	Length	Colour	Unit	Min. Order
0116152	25mm	50m	Kraft	Per roll	72 rolls
0116153	38mm	50m	Kraft	Per roll	48 rolls
0116154	50mm	50m	Kraft	Per roll	36 rolls
0116201	75mm	50m	Kraft	Per roll	24 rolls

Order by 3pm



Next day delivery on all stock items

**Self Adhesive Kraft Tape Small Core**

- 0116443 and 0116422 designed to fit your e-tape dispenser
- 0116411 designed for case tapers



Item Code	Width	Length	Colour	Unit	Min. Order
0116443	50mm	100m	Kraft	Per roll	36 rolls
0116422	72mm	100m	Kraft	Per roll	24 rolls
0116411	48mm	500m	Kraft	Per roll	6 rolls

**Reinforced S/Adhesive Kraft Tape**

- Recyclable tape
- 50mm width
- 25 metre roll length
- Min Order: 36 rolls



Item Code	Width	Length	Colour	Unit	Min. Order
0116420	50mm	25m	Kraft	Per roll	36 rolls

**Gummed Paper Tape**

- Gummed inside (GSI) or gummed outside (GSO)
- Water activated
- Recyclable tape



Item Code	Width	Length	Type	Colour	Unit	Min. Order
0116129	48mm	200m	GSI	Kraft	Per roll	30 rolls
0116142	48mm	200m	GSI	White	Per roll	30 rolls
0116130	48mm	200m	GSO	Kraft	Per roll	24 rolls
0116131	70mm	200m	GSI	Kraft	Per roll	18 rolls
0116132	70mm	200m	GSO	Kraft	Per roll	16 rolls
0116133	96mm	200m	GSI	Kraft	Per roll	12 rolls
0116134	96mm	200m	GSO	Kraft	Per roll	12 rolls

All gummed tapes without reinforcing filaments are 100% compostable

**Reinforced Gummed Paper Tape**

- Extra strong paper tape

Recommended tape for use with gummed tape dispensers. See page 58



Item Code	Width	Length	Type	Unit	Min. Order
0116140	48mm	100m	GSI	Per roll	24 rolls
0116141	70mm	100m	GSI	Per roll	6 rolls
0116448	70mm	152m	GSI	Per roll	6 rolls

**Pre-printed Reinforced Gummed Paper Tape**

- 152 metre roll length
- 6 rolls per box



Ask us about bespoke printing with your own message

Item Code	Width	Printed Message	Unit	Min. Order
0116138	70mm	Caution	Per roll	24 rolls
1116028	70mm	Sentry Seal	Per roll	16 rolls



Find gummed paper tape dispensers on pages 58-59

**Double Sided Tape**

- Double sided polypropylene tape



Item Code	Width	Length	Unit	Min. Order
0116051	12mm	50m	Per roll	144 rolls
0116052	19mm	50m	Per roll	60 rolls
0116053	25mm	50m	Per roll	48 rolls
0116056	50mm	50m	Per roll	24 rolls

**Double Sided Finger Lift Tape**

- Double sided adhesive tape
- Finger lift tissue



Item Code	Width	Length	Type	Unit	Min. Order
0116173	6/12mm	50m	Standard	Per roll	60 rolls
0116174	6/12mm	50m	High Tack	Per roll	60 rolls
0116175	12/18mm	50m	Standard	Per roll	40 rolls
0116176	12/18mm	50m	High Tack	Per roll	40 rolls
0116177	18/24mm	50m	Standard	Per roll	30 rolls
0116178	18/24mm	50m	High Tack	Per roll	30 rolls
0116335	24/30mm	50m	High Tack	Per roll	25 rolls

Join our mailing list

Receive emails with new products, bulk deals and offers.

Join now at [bonustrading.co.uk](http://bonustrading.co.uk)

# CUSTOM PRINTED TAPE

Printed tape with your logo and branding will help your shipments stay visible during transit and keep your brand memorable with your customers.

Custom printing has more uses beyond branding; you can promote goods and services, label product types, add caution messages or show instructions.

We can print on almost any tape including polypropylene, vinyl, e-tape, floor tape and paper tapes. Under surface printing options available. Tell us what you need and we'll print it.

**YOUR MESSAGE  
YOUR BRAND  
YOUR TAPE**



## Polythene Mailing Bags Grey PWN

- All have self-seal 40mm lip
- All have pre-printed warning notice
- Grey opaque bags
- 100% recycled polythene



Now 100% recycled plastic

## Polythene Mailing Bags Clear

- All have self-seal 40mm lip
- Plain clear bags



Ask us about custom printing

Item Code	Size (mm)	Size (in)	Unit
3316046	161 x 240	6 x 9.5	2000
3316039	250 x 350	10 x 14	1000
3316048	300 x 350	12 x 14	1000
3316049	350 x 400	14 x 16	1000
3316036	400 x 525	16 x 21	500
3316050	525 x 600	21 x 24	500
3316037	600 x 700	24 x 27.5	500
3316045	700 x 800	27.5 x 32	250

Item Code	Size (mm)	Size (in)	Size Ref	Unit
3316034	165 x 230	6.5 x 9	C5	1000
3316033	230 x 310	9 x 12	C4	1000
3316035	250 x 350	10 x 14	C4L	1000
3316032	330 x 440	13 x 17	C3	1000
3316065	115 x 230	4.5 x 9	DL	1000

Our mailing bags are 100% recyclable - via plastic bag and film recyclers



Peel & seal

Ask us about more options, with or without printed warning notice

Bespoke custom mailers can be ordered to meet your exact requirements. Please contact our sales team.



**CAN'T SEE WHAT YOU'RE LOOKING FOR?**

Call our sales team on **08000 540 100**

**Paper Mailers**

- Eco-friendly, hard wearing kraft paper mailers
- Recyclable and compostable
- Double fix closure options, ideal for returns

**Single Fix**

Item Code	Size	Flap & Fix	Per Pack
4216166	190 x 50 x 300mm	50mm Single	300
4216167	250 x 50 x 353mm	50mm Single	300
4216168	260 x 70 x 410mm	50mm Single	300
4216169	300 x 80 x 430mm	50mm Single	300
4216170	360 x 100 x 560mm	50mm Single	200

**Double Fix**

Item Code	Size	Flap & Fix	Per Pack
4216175	190 x 50 x 300mm	110mm Double	300
4216176	250 x 50 x 353mm	110mm Double	300
4216177	260 x 70 x 410mm	110mm Double	300
4216178	300 x 80 x 430mm	110mm Double	300
4216179	360 x 100 x 560mm	110mm Double	200



**Padded Envelopes**

- Protective bubble lined mailers
- OptiSafe brand, excellent quality
- Peel and seal
- 30% recycled plastic bubble film

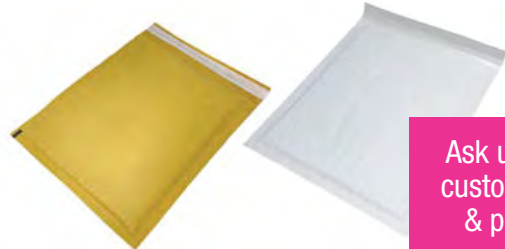

Ask us about custom sizing & printing

**Gold**

Item Code	Size	Size Ref	Unit
4216147	120 x 175mm	000/AG	200
4216146	140 x 225mm	00/BG	200
4216145	170 x 225mm	0/CG	100
4216148	200 x 275mm	1/DG	100
4216149	240 x 275mm	2/EG	100
4216150	240 x 350mm	3/FG	100
4216151	250 x 350mm	4/GG	100
4216152	290 x 370mm	5/HG	100
4216153	320 x 445mm	6/JG	50
4216154	370 x 480mm	7/KG	50
4216155	460 x 680mm	8/LG	50

**White**

Item Code	Size	Size Ref	Unit
4216010	120 x 175mm	000/AW	200
4216007	140 x 225mm	00/BW	200
4216004	170 x 225mm	0/CW	100
4216013	200 x 275mm	1/DW	100
4216017	240 x 275mm	2/EW	100
4216020	240 x 350mm	3/FW	100
4216023	250 x 350mm	4/GW	100
4216027	290 x 370mm	5/HW	100
4216030	320 x 445mm	6/JW	50
4216034	370 x 480mm	7/KW	50
4216037	460 x 680mm	8/LW	50

**Anti-Static Bubble Pouches Pink**

**Bubble Pouches Clear**

- OptiSafe brand
- Peel and seal
- 30% recycled



Item Code	Size	Size Ref	Unit
4216038	100 x 135mm	BB1	750
4216039	130 x 185mm	BB2	500
4216040	180 x 235mm	BB3	300
4216041	230 x 285mm	BB4	300
4216042	280 x 360mm	BB5	150
4216043	305 x 435mm	BB6	150
4216044	380 x 435mm	BB7	100
4216045	500 x 750mm	BB8	50
4216076	510 x 770mm	BB9	125

Item Code	Size	Size Ref	Unit
4116013	130 x 185mm	BB2/AS	500
4116014	180 x 235mm	BB3/AS	300
4116015	230 x 285mm	BB4/AS	300
4116016	280 x 360mm	BB5/AS	150
4116017	305 x 435mm	BB6/AS	150
4116018	380 x 435mm	BB7/AS	100

**Board Backed Manilla Envelopes**

- Pre-printed "Please do not bend"



Item Code	Size	Size Ref	Unit
1039015	324 x 229mm	C4	125
1039016	229 x 162mm	C5	125
1039020	324 x 458mm	C3	125

**Jiffy Bags**



Item Code	Size	Size Ref	Unit
4216059	107 x 235mm	PB00	200
4216058	132 x 235mm	PB0	200
4216060	164 x 285mm	PB1	100
4216061	196 x 285mm	PB2	100
4216062	196 x 350mm	PB3	100
4216063	221 x 350mm	PB4	100
4216064	247 x 387mm	PB5	100
4216065	298 x 464mm	PB6	50
4216066	336 x 489mm	PB7	50
4216067	437 x 665mm	PB8	50

**Cable Ties**

† 3516027 & 3516034 re-useable



Item Code	Size	Colour	Unit
3516011	100 x 2.5mm	Black	100
3516012	140 x 3.6mm	Black	100
3516013	142 x 3.2mm	Black	100
3516014	160 x 4.8mm	Black	100

Item Code	Size	Colour	Unit
3516043	140 x 3.6mm	White	100
3516034†	150 x 7.6mm	Black	100
3516015	200 x 4.8mm	Black	100
3516019	200 x 4.8mm	White	100
3516020	200 x 7.6mm	White	100
3516040	300 x 4.8mm	Black	100
3516016	300 x 7.6mm	Black	100
3516036	370 x 4.8mm	White	100
3516017	370 x 7.6mm	Black	100
3516027†	370 x 7.6mm	Black	100
3516021	370 x 7.6mm	White	100
3516035	430 x 4.8mm	Black	100
3516018	430 x 9.0mm	Black	100
3516031	430 x 9.0mm	White	100
3516041	780 x 9.0mm	Black	100

**Rubber Bands**

- Sold in unit weight of one pound (1lb)
- Quantities are approximate



Item Code	Size	Code	Colour	Unit
3516028	30 x 1.5mm	B10	Natural	2650
3516029	60 x 1.5mm	B16	Natural	1600
3516010	60 x 9.0mm	B71	Natural	280
3516032	80 x 1.5mm	B18	Natural	1250
3516038	80 x 1.5mm	B18W	White	1250
3516002	80 x 3.0mm	B32	Natural	600
3516006	89 x 6.0mm	B64	Natural	250
3516001	90 x 1.5mm	B19	Natural	1100
3516033	90 x 3.0mm	B33	Blue	500
3516003	100 x 3.0mm	B34	Natural	500
3516007	111 x 6.0mm	B66	Natural	250
3516030	122 x 1.5mm	B22	Natural	970
3516004	122 x 3.0mm	B36	Natural	430
3516008	140 x 6.0mm	B68	Natural	200
3516005	150 x 3.0mm	B38	Natural	330
3516009	150 x 6.0mm	B69	Natural	170
3516044	150 x 9.0mm	B79	Natural	120
3516045	180 x 6.0mm	B69	Natural	150

**Book Wraps with Tape Strip**

- Corrugated board, with self seal strip
- Ripper strip for easy opening



Item Code	Size (Internal)	Size Ref	Unit
4916851	235 x 157 x 60mm	A5	25
4916854	300 x 232 x 47mm	A4	25
4916855	327 x 270 x 47mm	A4 Large	25
4916744	300 x 250 x 70mm	A4 Deep	25
4916811	420 x 320 x 100mm	A3	20
4916852	620 x 456 x 70mm	A2	25

**Capacity Envelopes with Tape Strip**

- Solid board envelopes, suitable for books
- Ripper strip for easy opening
- Self seal strip



Item Code	Size	Size Ref	Unit
1039087	234 x 178mm	A5	50
1039088	291 x 194mm	A5 Large	50
1039089	333 x 233mm	A4	50
1039090	349 x 249mm	A4 Large	50

**Green Document Enclosed Wallets**

- Biodegradable



**Plain**

Item Code	Size	Size Ref	Unit
3416018	165 x 122mm	A6	1000
3416016	225 x 165mm	A5	1000
3416014	318 x 235mm	A4	500

**Pre-Printed "DOCUMENTS ENCLOSED"**

Item Code	Size	Size Ref	Unit
3416019	165 x 122mm	A6	1000
3416017	225 x 165mm	A5	1000
3416015	318 x 235mm	A4	500

**Document Enclosed Wallets**



See website for 100% paper options

**Plain**

Item Code	Size	Size Ref	Unit
3416010	113 x 100mm	A7	1000
3416003	165 x 122mm	A6	1000
3416008	225 x 165mm	A5	1000
3416006	318 x 235mm	A4	1000

**Pre-Printed "DOCUMENTS ENCLOSED"**

Item Code	Size	Size Ref	Unit
3416009	113 x 100mm	A7	1000
3416011	240 x 135mm	DL	1000
3416002	165 x 122mm	A6	1000
3416007	225 x 165mm	A5	1000
3416005	318 x 235mm	A4	1000

Single Wall Cartons



- Unit is each
- Sold in packs of 25



Single wall cartons can be made to your specifications

Call free on **08000 540 100** to speak to our advisers



Order by 3pm  
Next day delivery on all stock items



Item Code	Size (LxWxD) in	Size (LxWxD) mm
6316001	4 x 4 x 4	102 x 102 x 102
6316002	5 x 5 x 5	127 x 127 x 127
6316003	6 x 6 x 6	152 x 152 x 152
6316004	7 x 7 x 7	178 x 178 x 178
6316005	8 x 6 x 4	203 x 152 x 102
6316006	8 x 6 x 6	203 x 152 x 152
6316007	8 x 8 x 8	203 x 203 x 203
6316008	9 x 6 x 6	229 x 152 x 152
6316009	9.5 x 9.5 x 4.5	241 x 241 x 114
6316010	9 x 9 x 9	229 x 229 x 229
6316011	10.5 x 9.5 x 4	267 x 241 x 102
6316012	12 x 9 x 3	305 x 229 x 76
6316013	12 x 9 x 4	305 x 229 x 102

**ASK US ABOUT BULK BUY SAVINGS**

Double Wall Cartons

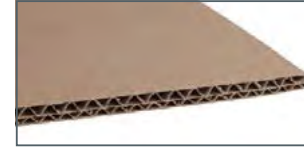

- Unit is each
- Sold in packs of 15



Double wall cartons can be made to your specifications

Call free on **08000 540 100** to speak to our advisers



Join our mailing list  
Receive emails with new products, bulk deals and offers.

Join now at [bonustrading.co.uk](http://bonustrading.co.uk)

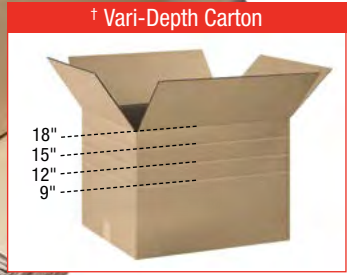

Item Code	Size (LxWxD) in	Size (LxWxD) mm
6416002	9 x 6 x 6	229 x 152 x 152
6416003	10 x 10 x 10	254 x 254 x 254
6416004	12 x 9 x 5	305 x 229 x 127
6416005	12 x 9 x 6	305 x 229 x 152
6416006	12 x 9 x 9	305 x 229 x 229
6416007	12 x 12 x 12	305 x 305 x 305
6416008	14 x 10.25 x 12	356 x 260 x 305
6416009	14 x 14 x 14†	356 x 356 x 356†
6416010	16 x 16 x 16	406 x 406 x 406
6416011	18 x 12 x 10	457 x 305 x 254
6416012	18 x 12 x 12†	457 x 305 x 305†
6416013	18 x 18 x 18†	457 x 457 x 457†
6416014	18 x 18 x 12†	457 x 457 x 305†
6416015	18 x 18 x 20	457 x 457 x 508
6416016	18 x 18 x 30	457 x 457 x 762
6416017	20 x 20 x 20	508 x 508 x 508
6416018	23 x 15 x 13.5	584 x 381 x 343
6416019	23 x 11 x 14.5	584 x 279 x 368
6416020	22.25 x 14 x 14.5	565 x 356 x 368
6416021	22.25 x 14 x 22	565 x 356 x 559
6416022	24 x 18 x 18†	610 x 457 x 457†
6416023	24 x 24 x 24†	610 x 610 x 610†
6416024	30 x 18 x 12	762 x 457 x 305
6416025	30 x 18 x 18†	762 x 457 x 457†
6416026	30 x 20 x 20	762 x 508 x 508
6416027	36 x 36 x 36	914 x 914 x 914
6416028	12 x 9 x 12	305 x 229 x 305
6416029	12 x 9 x 3	305 x 229 x 76
6416043	18 x 12 x 6	457 x 305 x 152

† Vari-depth

**ASK US ABOUT BULK BUY SAVINGS**

**Ecommerce Postal Boxes**

- Designed for ease of use at Royal Mail delivery sizes
- Quick assembly with easy-fold self locking mechanism
- Supplied flat and pre-printed with size, barcode and SKU/item code

Quick and easy assembly



**Royal Mail Small Parcel**

Item Code	Size (LxWxD) mm	Unit	Min. Order
7416120	102 x 80 x 60	Each	50
7416141	127 x 102 x 80	Each	50
7416130	152 x 102 x 70	Each	50
7416140	160 x 80 x 80	Each	50
7416110	180 x 102 x 51	Each	50
7416150	200 x 102 x 102	Each	50
7416131	203 x 140 x 76	Each	50
7416111	215 x 152 x 51	Each	50
7416151	254 x 203 x 102	Each	50
7416142	270 x 180 x 80	Each	50
7416152	300 x 250 x 100	Each	50
7416112	310 x 220 x 51	Each	50
7416009	415 x 337 x 70	Each	25
7416016	450 x 350 x 158	Each	25

**Royal Mail Large Letter**

Item Code	Size (LxWxD) mm	Unit	Min. Order
7416100	101 x 101 x 20	Each	50
7416010	112 x 163 x 20	Each	50
7416012	217 x 108 x 20	Each	50
7416101	218 x 159 x 20	Each	50
7416102	320 x 230 x 20	Each	50

- Ecommerce Postal Cartons are ideal for sending items such as mugs, books, calendars and gifts



See void fill on page 34

Our range of labels start on page 90

We can help you choose the best sizes for all your items



**BDCM Cartons**

- High quality 'Bulk Distribution Carton Metric' boxes
- Pre-printed with standard information panels in blue
- Strong single wall construction
- 7816010 is double wall
- 7816009 is unprinted



Item Code	Type	Size (LxWxD) mm	Unit
7816001	BDCM1	595 x 295 x 388	Each
7816010	BDCM1 DW	587 x 283 x 375	Each
7816002	BDCM2	400 x 300 x 400	Each
7816003	BDCM4	394 x 292 x 191	Each
7816004	BDCM3	597 x 292 x 190	Each
7816009	BDCM3 Blank	597 x 292 x 190	1000

**Archive Boxes**

- Extra heavy duty boxes
- Boxes can be assembled quickly and easily
- Re-useable & easy to collapse
- No staples
- 100% recyclable
- Compact to store
- Keep archive files safe in storage
- Ideal for solicitors, accountants, architects and planning departments

Please contact our sales team for the latest archive box options

**White Easy-Fold Postal Boxes**

- Single wall with white outer
- Easy fold with hinged lid and tuck in tab



Item Code	Size (LxWxD) mm	Unit
7416001	100 x 80 x 60	Each
7416002	120 x 100 x 80	Each
7416003	150 x 150 x 60	Each
7416004	170 x 140 x 55	Each
7416005	200 x 100 x 100	Each
7416006	250 x 150 x 50	Each
7416007	305 x 152 x 50	Each
7416008	300 x 250 x 100	Each



**Large Bubble Wrap Clear**

- Standard wrap is quality OptiSafe brand
- Some widths are supplied as pre-cut wider rolls, resulting in unit bundles of 2, 3 or 5 smaller rolls
- 30% recycled
- 50m length rolls



Item Code	Width	Type	Unit
4316004	300mm	Standard	5 rolls
4316006	500mm	Standard	3 rolls
4316056	500mm	Jiffy Easy Tear	3 rolls
4316007	600mm	Standard	2 rolls
4316008	750mm	Standard	2 rolls
4316048	750mm	Jiffy Easy Tear	2 rolls
4316001	1000mm	Standard	Roll
4316002	1200mm	Standard	Roll
4316061	1200mm	Jiffy Easy Tear	Roll
4316003	1500mm	Standard	Roll
4316053	1500mm	Jiffy	Roll

**Small Bubble Wrap Clear**

- Standard wrap is quality OptiSafe brand
- 4316028 is perforated every 300mm, for a straight tear
- 30% recycled
- 100m length



Item Code	Width	Type	Unit
4316023	300mm	Standard	5 rolls
4316038	300mm	Jiffy	5 rolls
4316024	500mm	Standard	3 rolls
4316026	600mm	Standard	2 rolls
4316054	600mm	Jiffy Easy Tear	2 rolls
4316027	750mm	Standard	2 rolls
4316050	750mm	Jiffy Easy Tear	2 rolls
4316028	750mm	Perforated Jiffy (300mm)	2 rolls
4316029	900mm	Standard	Roll
4316013	1000mm	Standard	Roll
4316014	1200mm	Standard	Roll
4316039	1200mm	Jiffy Easy Tear	Roll
4316018	1500mm	Standard	Roll
4316057	1500mm	Jiffy	Roll
4316021	1800mm	Standard	Roll
4316022	2000mm	Standard	Roll

**Eco Bubble - made with up to 50% recycled film**

Item Code	Width	Type	Unit
4316070	300mm	Eco	5 rolls
4316069	500mm	Eco	3 rolls
4316068	750mm	Eco	2 rolls
4316067	1000mm	Eco	Roll
4316066	1200mm	Eco	Roll
4316065	1500mm	Eco	Roll

**Biodegradable · Fire Retardant**

Item Code	Width	Type	Unit
4316058	500mm	Biodegradable	3 rolls
4316033	1500mm	Biodegradable	Roll
4316051	1800mm	Fire Retardant	Roll

**Wrap roll unit bundle examples**

Some widths are supplied as pre-cut wider rolls, resulting in unit bundles of 2, 3 or 5 narrower rolls

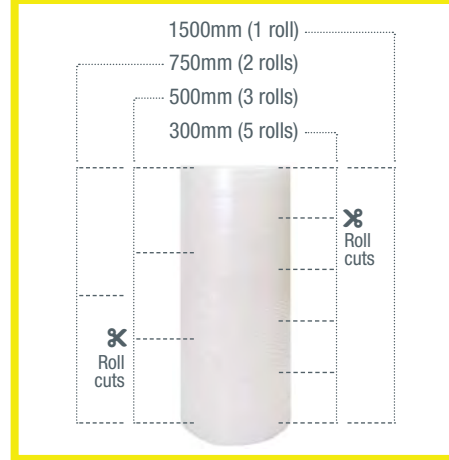

**Anti-static Small Bubble Wrap Pink**

- 100 metre length rolls



Item Code	Width	Unit
4116011	750mm	2 rolls
4116007	1200mm	Roll
4116008	1500mm	Roll

**Protective Foam Wrap White**

- Ideal protection for glass and delicate goods



Item Code	Width	Length	Thickness	Unit
4416005	500mm	300m	1mm	3 rolls
4416001	500mm	200m	1.5mm	3 rolls
4416008	500mm	120m	2.5mm	3 rolls
4416013	500mm	75m	4mm	3 rolls
4416012	750mm	120m	2.5mm	2 rolls
4416037	750mm	75m	4mm	2 rolls
4416006	1000mm	300m	1mm	Roll
4416002	1000mm	300m	1.5mm	Roll
4416009	1000mm	120m	2.5mm	Roll
4416014	1000mm	75m	4mm	Roll
4416007	1500mm	300m	1mm	Roll
4416016	1500mm	75m	4mm	Roll

**Perforated Foam Wrap**

Item Code	Width	Length	Thickness	Unit
4416056	1000mm	120m	2.5mm	Roll

See next page for unit bundle examples



Small bubble wrap is available in eco or biodegradable options

**Postal Tubes**

- Sturdy cardboard tubes with plastic end caps
- Tubes are recyclable and compostable
- End caps are recyclable
- Ideal for posters, maps and fabrics



Recyclable  
and compostable

**Tubes with End Caps**

Item Code	Length	Diam	Wall	Fits	Unit
5616033	330mm	38mm	1.5mm	A3	Each
5616047	330mm	50mm	1.5mm	A3	Each
5616057	450mm	38mm	1.5mm	A2	Each
5616032	450mm	50mm	1.5mm	A2	Each
5616058	450mm	63mm	2mm	A2	Each
5616095	450mm	76mm	1.5mm	A2	Each
5616064	538mm	76mm	2.5mm	B2	Each
5616020	624mm	50mm	1.5mm	A1	Each
5616059	632mm	63mm	2mm	A1	Each
5616060	632mm	76mm	2.5mm	A1	Each
5616065	745mm	50mm	1.5mm	B1	Each
5616066	757mm	76mm	2.5mm	B1	Each
5616067	757mm	101mm	3mm	B1	Each
5616061	891mm	76mm	2.5mm	A0	Each
5616062	891mm	101mm	3mm	A0	Each
5616063	891mm	152mm	3mm	A0	Each
5616068	1050mm	76mm	2.5mm	B0	Each
5616069	1050mm	101mm	3mm	B0	Each
5616070	1050mm	152mm	3mm	B0	Each

**Packs of End Caps**

Item Code	Diam	Unit	Min. Order
5616013	76mm	Each	200
5616015	90mm	Each	100



Need a different size?  
We can supply bespoke tubes to  
suit your requirements.  
Ask our sales team

**Foam Transit Pads**

- For separating and protecting surfaces
- Ideal for transport of glass or delicate panels
- 4mm thick

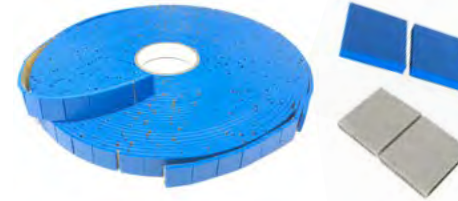

Item Code	Size	Colour	Unit
9512001	23 x 18mm	Blue	Roll 1000
9512066	25 x 25mm	Blue	Roll 800
9512022	25 x 25mm	Grey	Roll 800

**Plastic Corner Protectors**

- Providing extra protection for items like panels and frames

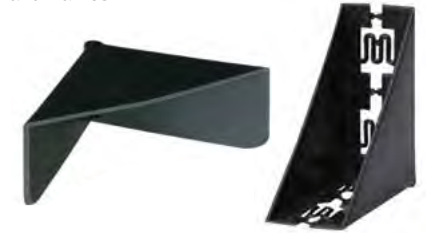

Item Code	Size / Description (mm)	Unit
4016028	16-40 Expandable	Box 1000
4016020	60 x 60 x 15 Closed	Box 1000
4016021	60 x 60 x 18 Closed	Box 1000
4016022	60 x 60 x 22 Closed	Box 850
4016023	60 x 60 x 28 Closed	Box 700
4016378	60 x 60 x 28 Closed Heavy Duty	Box 800
4016379	60 x 60 x 40 Closed	Box 600

**Foam Edge Protectors Green**

- U and L channel foam
- 100% recycled, 100% recyclable



**U Channel**

Item Code	Size Ref	Internal Size	Length	Mtrs/Box
4416069	U15	0-15mm	2m	500m
4416070	U25	15-25mm	2m	280m
4416071	U35	25-35mm	2m	180m
4416072	U45	35-45mm	2m	160m
4416073	U60	45-60mm	2m	100m

**L Channel**

4416074	L50	50mm	2m	480m
4416075	L75	75mm	2m	210m

**Foam Edge Corners Green**

- U channel foam corners
- 100% recycled, 100% recyclable
- Ideal protection for frames and sheet materials



All foam edge protectors are now 100% recycled green foam

Item Code	Size Ref	Internal Size	Unit
4416064	U15	0-15mm	Box 900
4416065	U25	15-25mm	Box 600
4416066	U35	25-35mm	Box 400
4416067	U45	35-45mm	Box 300
4416068	U60	45-60mm	Box 200

**V-Board Pallet Edge Protectors**

- Protect pallets in storage and transit
- Use with strapping or wrap to secure pallet contents



Item Code	Size	Length	Wall	Unit
4716032	35 x 35mm	0.5m	2mm	Each
4716009	35 x 35mm	1m	3mm	Each
4716012	35 x 35mm	2m	3mm	Each
4716015	35 x 35mm	2m	3mm	1000
4716027	50 x 50mm	0.2m	3mm	Each
4716006	50 x 50mm	1.5m	3mm	Each
4716007	50 x 50mm	1.8m	3mm	Each
4716008	50 x 50mm	2m	3mm	Each
4716013	75 x 75mm	2m	6mm	1000
4716014	80 x 80mm	1.2m	4mm	Each

**Plastic Strapped Edge Protectors**

- Edge protection preventing strapping from digging into the packaging
- Size options for use with straps up to 19mm or up to 30mm in width



Item Code	Description	Unit
4016025	28 x 25mm (up to 19mm strap)	2000
4016024	37 x 32mm (up to 30mm strap)	1000

**Cardboard Layer Pads**

- Min. order 1000 units
- Single wall



Ask us for bespoke sizes

Item Code	Size	Unit
3716360	255mm x 155mm	Each
3716361	300mm x 230mm	Each
3716029	370mm x 271mm	Each
4916525	605mm x 605mm	Each
3716368	800mm x 800mm	Each
3716362	800mm x 1200mm	Each
3716014	1000mm x 1200mm	Each
3716025	1130mm x 1130mm	Each

**Corrugated Kraft Paper**

- Provides a layer of surface protection
- Ideal for separating individual products
- 75 metre length rolls



We can supply bespoke paper and card sizes

Item Code	Width	Unit
4616006	200mm	Roll
4616010	450mm	Roll
4616012	600mm	Roll
4616015	650mm	Roll
4616013	750mm	Roll
4616014	900mm	Roll
4616001	1000mm	Roll
4616017	1100mm	Roll
4616002	1200mm	Roll
4616004	1500mm	Roll
4616005	1800mm	Roll
4616007	2000mm	Roll



**Kraft Union Paper**

- Moisture and water resistant barrier
- 100 metre length rolls



Item Code	Width	Paper Weight	Unit
3816014	900mm	120gsm	Roll
3816012	1200mm	165gsm	Roll
3816013	1800mm	120gsm	Roll

**MG Pure Ribbed Kraft Paper**

- For medium and heavy duty packing

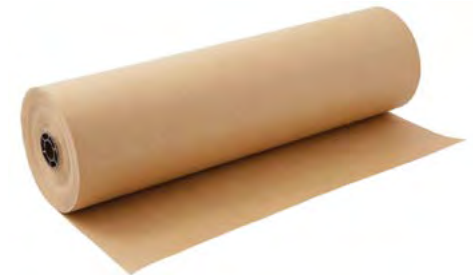

Item Code	Width	Length	Weight	Unit
3816019	450mm	285m	70gsm	Roll
3816020	500mm	285m	70gsm	Roll
3816021	600mm	285m	70gsm	Roll
3816022	750mm	285m	70gsm	Roll
3816023	900mm	285m	70gsm	Roll
3816024	900mm	220m	88gsm	Roll

**Tissue Paper**

- Protect and separate delicate items
- MG tissue is high quality acid free
- Many more colours available to match your brand



More colours available

Ask us about bespoke sizes and custom printing

Item Code	Description	Colour	Size	Weight	Sheets Per Ream/Unit
3816004	Standard Tissue	Off White	750mm x 500mm	18gsm	480
3816029	Acid Free Tissue	White	750mm x 500mm	18gsm	480
3816037	Acid Free MG Tissue	White	700mm x 450mm	18gsm	480
3816027	Acid Free Tissue	Red	750mm x 500mm	16gsm	480
3816028	Acid Free Tissue	Black	750mm x 500mm	16gsm	480

**Waxed Kraft Paper**

- For protecting oiled or greased items
- Min. order of 2 rolls



Item Code	Width	Length	Weight	Unit
3816026	900mm	100m	55gsm	Roll

**News Off Cuts**

- Unprinted newsprint paper
- Ideal for wrapping ceramics and glass
- Approx. 550 sheets per pack



Item Code	Width	Length	Unit
3816015	500mm	750mm	10kg pack

**Honeycomb Paper Wrap**

- Efficient protective paper wrapping system
- Stretches to reveal honeycomb structure
- Roll length 268m (425m when stretched)



Item Code	Description	Size	Unit
4516012	Paper Roll	390mm x 268m(425m)	Each
4516013	Dispenser	For 390mm roll	Each

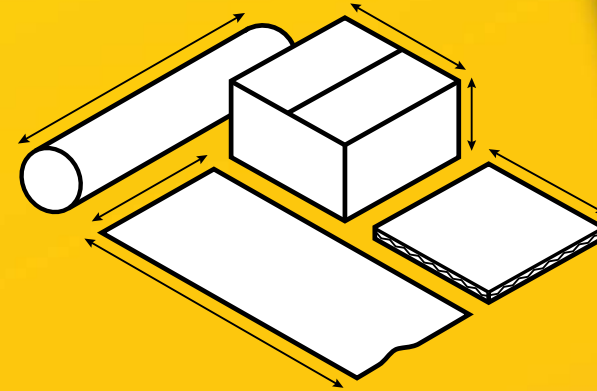

**CUSTOM SIZES & PRINTING**

**THE PERFECT PACKAGING**

Boxes, tubes, sheet papers and rolls available in bespoke sizes, with dimensions to suit your products.

Use the most efficient sized packaging for optimal space saving during storage, transport and delivery.

You can also add printed branding, icons or messages to any size packaging you need. Ask our sales team for details of all our available options.



**Grip® PaperFill Void Fill**

- Grip PaperFill void fill boxes and stand
- Height adjustable tray, for easy dispensing
- Attach to any workbench, adjustable to any angle
- Robust, high quality, powder coated steel



Item Code	Description
1616020	Grip PaperFill Void Fill Stand
1616019	Grip PaperFill Void Fill Box



- Easy-open box contains single ply void fill
- Roll 375mm x 350m
- Recycled and recyclable

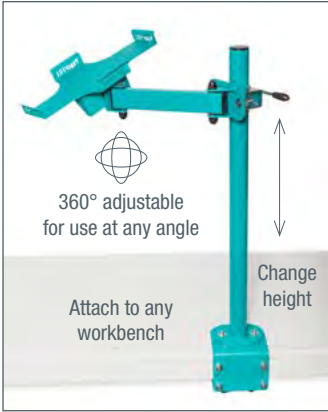

**Paper Void Fill Rolls**

- Classic void fill roll for dispensing machine (6616064)

4516003



See dispensers on pages 61-62

Item Code	Description	Width	Length	Unit
4516003	Classic Void Fill	610mm	325m	Roll

**Paperplus Papillon Paper Void Fill**

- For use with Papillon Void Fill machines
- Brown - 2.24m³ per box. Black - 2.5m³ per box



Item Code	Description	Colour	Width	Length	Unit
4516001	P/P Void Fill	Brown	200mm	280m	Box
4516005	P/P Void Fill	Black	200mm	320m	Box

**InstaPak Quick Foam Cushions**

- Easy to use, pressure activated foam packaging
- Fast expanding to fill void and secure products
- Custom fit, ideal for fragile and delicate items
- Recommended use box sizes:  
No.10 - 200 x 200 x 200mm / 8 x 8 x 8in  
No.20 - 250 x 250 x 250mm / 10 x 10 x 10in  
No.40 - 300 x 300 x 300mm / 12 x 12 x 12in  
No.60 - 350 x 350 x 350mm / 14 x 14 x 14in  
No.80 - 455 x 300 x 300mm / 18 x 12 x 12in  
No.100 - 405 x 405 x 405mm / 16 x 16 x 16in



Item Code	Description	Flat Size	Unit	Bulk Ordering
4016361	InstaPak No.10	380x460mm	36	Item Code Description Flat Size Unit
4016362	InstaPak No.20	460x460mm	36	4016357 InstaPak No.10 380x460mm 180
4016363	InstaPak No.40	460x610mm	30	4016352 InstaPak No.20 460x460mm 144
4016364	InstaPak No.60	460x610mm	30	4016358 InstaPak No.40 460x610mm 112
4016365	InstaPak No.80	540x680mm	24	4016353 InstaPak No.60 460x610mm 120
4016366	InstaPak No.100	640x690mm	24	4016359 InstaPak No.80 540x680mm 72
4016367	InstaPak Starter Kit	Various	18	4016360 InstaPak No.100 640x690mm 72

**Loose Fill & Bio Loose Fill**

- Good protection for fragile items
- S shape chips, interlocking structure
- Fastfil - Reusable / Recyclable
- Biofil - Reusable / Biodegradable



Item Code	Description	Unit
6016002	0.425m³ Fastfil Bag	Each
6016001	0.425m³ Biofil Bag	Each

**Elasticated Corrugated Bottle Sleeves**

- Corrugated cardboard bottle protection
- Stretches to fit various bottle sizes
- 4516017 - sized for beer bottles, 20mm base fold
- 4516015 - sized for wine bottles, 30mm base fold



Item Code	Size	Unit
4516017	55-65mm dia. x 220mm+base fold	150
4516015	70-90mm dia. x 270mm+base fold	100

**Bottle Air Bags**

- Air filled bubble chamber bags for protecting glass and delicate bottles
- Designed for wine and beer bottle sizes
- Supplied deflated and flat packed / boxed
- Use an air compressor to inflate bag chambers, or a manual air pump for occasional use
- Reusable, ideal for supplying restaurants, retail outlets and direct delivery to consumers



**3216028**

**3216030**

**3216033**

Item Code	Description	Inflated Bag Dimensions (LxWxH)	Gauge	Unit
3216021	Magnum Air Bags	140 x 530 x 170mm	560	200
3216028	Wine - Treble Bottle Air Bags	100 x 390 x 120mm(x3)	415	100
3216029	Wine - Double Bottle Air Bags	100 x 390 x 120mm(x2)	415	150
3216030	Wine - Single Bottle Air Bags	100 x 390 x 110mm	410	250
3216031	75cl Bottle Air Bags	115m x 310 x 145mm	340	300
3216032	Small Bottle Air Bags	75 x 285 x 90mm	313	300
3216033	Beer - Treble Bottle Air Bags	110 x 310 x 115mm(x3)	345	150



**3216037**

**3216036**

**3216035**

**Biodegradable Bottle Air Bags**

Item Code	Description	Inflated Bag Dimensions (LxWxH)	Gauge	Unit
3216037	Wine - Bio Treble Bottle Air Bags	100 x 390 x 120mm(x3)	415	100
3216036	Wine - Bio Double Bottle Air Bags	100 x 390 x 120mm(x2)	415	150
3216035	Wine - Bio Single Bottle Air Bags	100 x 390 x 110mm	410	250



**Air Bag Inflating**

For medium to high volume requirements, it is recommended to use a suitable air compressor for inflating bags. A manual hand pump is only suggested for low volume, occasional use.

- Compressor has 3.5ltr tank and is supplied with foot pedal and nozzle

**6616103**



Item Code	Description	Unit
6616102	Small Compressor 3.5ltr - for Air Bags - frequent use	Each
6616103	Small Hand Pump - for Air Bags - occasional use	Each

**6616102**

**Air Pillow and Cushion Films**

Light as a feather and reliably shock-resistant, air pillows are the optimal protective packaging for sensitive products. A variety of pillow and cushion shapes can be produced as required directly at the packing station, therefore saving valuable storage space.

All AIRplus® machine types can be integrated into existing packing processes – including in combination with automated packing lines and storage containers at the packing station. Our range includes pillow, cushion and bubble films.



Ask us about free machine hire



**AIRplus Film**

Item Code	Type	Width	Height	Roll Length	Unit
3216003	Pillow	200mm	65mm	1125m	Roll
3216004	Pillow	200mm	120mm	1125m	Roll
3216005	Pillow	200mm	175mm	1125m	Roll
3216015	2 Pillow	400mm	150mm	500m	Roll
3216019	Bubble	400mm	160mm	500m	Roll

AIRplus film is now 50% recycled plastic

**Airtech Film**

Item Code	Type	Width	Height	Roll Length	Unit
3216013	Pillow	200mm	120mm	250m	Roll
3216011	Cushion	400mm	250mm	250m	Roll
3216012	Cushion - 16 pocket	400mm	250mm	500m	Roll

For air cushion and pillow machines see page 63

**Clear Polythene Bags**



**120 gauge 30 micron**

Item Code	Size (mm)	Size (in)	Unit
2716046	102 x 152	4 x 6	Box 1000
2716052	152 x 203	6 x 8	Box 1000
2716061	203 x 254	8 x 10	Box 1000
2716007	254 x 305	10 x 12	Box 1000
2716011	254 x 381	10 x 15	Box 1000
2716015	305 x 381	12 x 15	Box 1000
2716020	305 x 457	12 x 18	Box 1000
2716024	381 x 508	15 x 20	Box 1000
2716088	457 x 610	18 x 24	Box 500
2716033	508 x 762	20 x 30	Box 500
2716038	610 x 914	24 x 36	Box 500
2716042	914 x 1219	36 x 48	Box 250

**250 gauge 62.5 micron**

Item Code	Size (mm)	Size (in)	Unit
2716048	102 x 152	4 x 6	Box 1000
2716054	152 x 203	6 x 8	Box 1000
2716063	203 x 305	8 x 10	Box 500
2716009	254 x 305	10 x 12	Box 500
2716022	305 x 457	12 x 18	Box 500
2716026	381 x 508	15 x 20	Box 250
2716031	457 x 610	18 x 24	Box 200
2716035	508 x 762	20 x 30	Box 100
2716040	610 x 914	24 x 36	Box 100
2716044	914 x 1219	36 x 48	Box 100

**500 gauge 125 micron**

Item Code	Size (mm)	Size (in)	Unit
2716049	102 x 152	4 x 6	Box 500
2716055	152 x 203	6 x 8	Box 500
2716184	152 x 229	6 x 9	Box 2000
2716059	178 x 229	7 x 9	Box 500
2716064	203 x 305	8 x 10	Box 250
2716010	254 x 305	10 x 12	Box 250
2716014	254 x 381	10 x 15	Box 250
2716019	305 x 381	12 x 15	Box 250
2716023	305 x 457	12 x 18	Box 500
2716027	381 x 508	15 x 20	Box 200
2716032	457 x 610	18 x 24	Box 200
2716036	508 x 762	20 x 30	Box 50
2716041	610 x 914	24 x 36	Box 50
2716045	914 x 1219	36 x 48	Box 50

**200 gauge 50 micron**

Item Code	Size (mm)	Size (in)	Unit
2716047	102 x 152	4 x 6	Box 1000
2716053	152 x 203	6 x 8	Box 1000
2716066	203 x 305	8 x 10	Box 1000
2716008	254 x 305	10 x 12	Box 500
2716012	254 x 381	10 x 15	Box 500
2716016	305 x 381	12 x 15	Box 500
2716021	305 x 457	12 x 18	Box 500
2716025	381 x 508	15 x 20	Box 1000
2716030	457 x 610	18 x 24	Box 125
2716039	610 x 914	24 x 36	Box 125
2716043	914 x 1219	36 x 48	Box 100

**Grip Seal WOP (Write On Panel) Bags Clear**

- Sealable medium duty clear polythene bags
- White write-on panels for labelling contents etc



**160 gauge 40 micron**

Item Code	Size (mm)	Size (in)	Unit
3116001	38 x 63	1.5 x 2.5	Box 1000
3116002	57 x 57	2.25 x 2.25	Box 1000
3116003	57 x 76	2.25 x 3	Box 1000
3116004	76 x 89	3 x 3.25	Box 1000
3116005	89 x 114	3.5 x 4.5	Box 1000
3116006	114 x 114	4.5 x 4.5	Box 1000
3116007	102 x 140	4 x 5.5	Box 1000
3116008	140 x 140	5.5 x 5.5	Box 1000
3116009	76 x 191	3 x 7.5	Box 1000
3116010	127 x 191	5 x 7.5	Box 1000
3116011	191 x 191	7.5 x 7.5	Box 1000

**180 gauge 45 micron**

Item Code	Size (mm)	Size (in)	Unit
3116012	152 x 229	6 x 9	Box 1000
3116013	203 x 279	8 x 11	Box 1000
3116014	229 x 324	9 x 12.75	Box 1000
3116015	254 x 355	10 x 14	Box 1000
3116052	279 x 406	11 x 16	Box 1000
3116055	381 x 508	15 x 20	Box 1000

Ask us about bespoke sizes and custom printing & branding

**Grip Seal Bags**

- Sealable clear polythene bags



**160 gauge 40 micron**

Item Code	Size (mm)	Size (in)	Unit
3116016	38 x 64	1.5 x 2.5	Box 1000
3116017	57 x 57	2.25 x 2.25	Box 1000
3116027	57 x 76	2.25 x 3	Box 1000
3116033	76 x 191	3 x 7.5	Box 1000
3116029	89 x 114	3.5 x 4.5	Box 1000
3116031	102 x 140	4 x 5.5	Box 1000
3116030	114 x 114	4.5 x 4.5	Box 1000
3116034	127 x 191	5 x 7.5	Box 1000
3116032	140 x 140	5.5 x 5.5	Box 1000
3116018	191 x 191	7.5 x 7.5	Box 1000

**160 gauge 40 micron - Pink Anti-Static**

4116005	102 x 140	4 x 5.5	Box 1000
4116032	102 x 152	4 x 6	Box 1000

**180 gauge 45 micron**

Item Code	Size (mm)	Size (in)	Unit
3116020	152 x 229	6 x 9	Box 1000
3116021	203 x 279	8 x 11	Box 1000
3116035	229 x 324	9 x 12.75	Box 1000
3116022	324 x 324	12.75 x 12.75	Box 1000
3116023	254 x 356	10 x 14	Box 1000
3116024	279 x 406	11 x 16	Box 1000
3116025	330 x 457	13 x 18	Box 1000
3116026	381 x 508	15 x 20	Box 1000

**200 gauge 50 micron - Red**

3116049	102 x 140	4 x 5.5	Box 1000
---------	-----------	---------	----------

**300 gauge 75 micron**

Item Code	Size (mm)	Size (in)	Unit
3116036	127 x 203	5 x 8	Box 1000
3116037	178 x 254	7 x 10	Box 1000
3116039	229 x 356	9 x 14	Box 1000

**Polythene Layflat Tubing**

- 25kg max roll weight



Order by 3pm

Next day delivery on all stock items

Join our mailing list

Receive emails with new products, bulk deals and offers.

Join now at [bonustrading.co.uk](http://bonustrading.co.uk)

**120 gauge 30.5 micron**

Item Code	Size (mm)	Size (in)	Approx Length	Unit
3016051	762	30	600m	Roll
3016052	914	36	500m	Roll

**250 gauge 63.5 micron**

Item Code	Size (mm)	Size (in)	Approx Length	Unit
3016009	51	2	335m	Roll
3016012	76	3	335m	Roll
3016016	102	4	335m	Roll
3016018	127	5	335m	Roll
3016019	152	6	335m	Roll
3016020	178	7	335m	Roll
3016021	203	8	335m	Roll
3016023	229	9	335m	Roll
3016003	254	10	335m	Roll
3016004	305	12	335m	Roll
3016005	330	13	335m	Roll
3016047	356	14	335m	Roll
3016006	381	15	335m	Roll
3016007	406	16	335m	Roll
3016008	457	18	335m	Roll
3016001	508	20	335m	Roll
3016011	610	24	335m	Roll
3016013	762	30	265m	Roll
3016014	914	36	235m	Roll
3016017	1245	49	175m	Roll

**500 gauge 127 micron**

Item Code	Size (mm)	Size (in)	Approx Length	Unit
3016054	38	1.5	165m	Roll
3016030	51	2	165m	Roll
3016053	64	2.5	165m	Roll
3016035	76	3	165m	Roll
3016038	102	4	165m	Roll
3016046	127	5	165m	Roll
3016041	152	6	165m	Roll
3016043	203	8	165m	Roll
3016044	229	9	165m	Roll
3016025	254	10	165m	Roll
3016026	305	12	165m	Roll
3016027	330	13	165m	Roll
3016028	406	16	165m	Roll
3016029	457	18	165m	Roll
3016031	508	20	165m	Roll
3016033	610	24	165m	Roll
3016034	660	26	165m	Roll
3016036	762	30	140m	Roll
3016037	914	36	120m	Roll
3016039	1219	48	90m	Roll

**Pallet Top Sheets**

**Clear**

Item Code	Colour	Dimensions	Unit
3616014	Clear	900/1800 x 1800mm	Roll 150
3616017	Clear	900/1800 x 1600mm	Roll 500
3616018	Clear	855/1710 x 1710mm	Roll 200
3616020	Clear	1000 x 1200mm	Box 500
3616030	Clear	700/1400 x 1600mm	Roll 250
3616032	Clear	1000/2000mm	100m roll

**Grey**

3616019	Grey	1000/2000mm	100m roll
---------	------	-------------	-----------

**Black**

3616009	Black	900/1800 x 1800mm	Roll 150
---------	-------	-------------------	----------

**Blue Tint**

3616011	Blue	1600 x 1400mm	Box 300
3616031	Blue	1500 x 1500mm	Roll 100



**Refuse Sacks**

- A range of everyday refuse sacks



Item Code	Colour	Dimensions (in)	Gauge	Unit
2716193	Clear	18 x 29 x 39	120	Pack 200
2716108	Black	18 x 29 x 39	140	Pack 200
2716096	Black	18 x 29 x 39	180	Pack 200
2716101	Clear	18 x 29 x 39	180	Pack 200
2716173	Black	18 x 29 x 38	240	Pack 100
2716102	Black	20 x 34 x 39	180	Pack 200
2716106	Black	22 x 33 x 47	120	Pack 100
2716109	Black	22 x 33 x 47	260	Pack 100
2716110	Clear	22 x 34 x 47	260	Pack 100
2716128	Black	28 x 41 x 55	320	Pack 50

**Sack Ties**

- PVC coated sack ties and tying tool



Item Code	Description	Unit
3516023	6" Sack Ties	1000
3516024	9" Sack Ties	1000
7016041	Sack Tying Tool	Each

**Gusset Shrink Tubing**

- Ideal for variable pallet heights

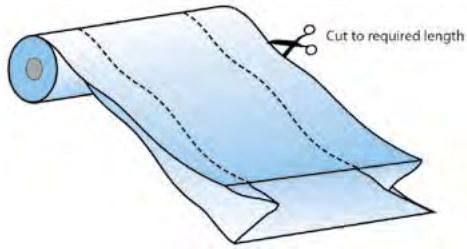

Item Code	Size	Length	Micron	Unit
2816001	1250/2250mm	50m	125	Roll
2816002	1200/2300mm	30m	200	Roll

**Centrefold Polythene Sheeting**

- Ideal for awkward shapes such as trucks/trolleys

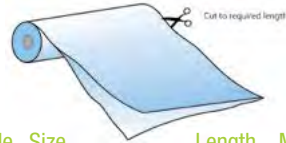

Item Code	Size	Length	Micron	Unit
2816003	1250/2500mm	85m	125	Roll
2816170	1250/2250mm	85m	125	Roll

**Gusset Shrink Bags**

- For loads approx 1200mm in height
- Supplied in rolls with perforations

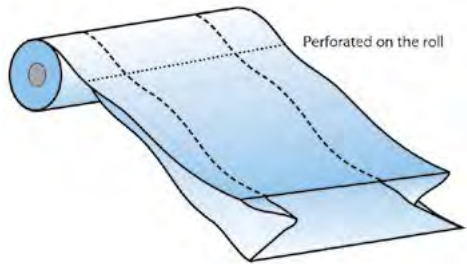

Item Code	Load Size	Pallet Cover Size	Micron	Covers/Roll	Unit
2816006	1200 x 800mm	1300/2150 x 1850mm	125	30	Roll
2816004	1200 x 1000mm	1300/2350 x 1950mm	125	30	Roll
2816005	1200 x 1200mm	1300/2550 x 2050mm	125	25	Roll



For shrink film guns see page 75

**PVC Shrink Film Clear**

- Responds quickly to heat giving effective results
- Shrinks tight round any shaped product
- Keeps the product clean and dust free



Item Code	Width	Length	Micron	Unit
2816008	200/400mm	600m	19	Roll
2816009	250/500mm	600m	19	Roll
2816010	300/600mm	600m	19	Roll
2816011	350/700mm	600m	19	Roll
2816012	400/800mm	600m	19	Roll
2816013	450/900mm	600m	19	Roll
2816014	500/1000mm	600m	19	Roll
2816018	450/900mm	300m	38	Roll
2816019	450/900mm	450m	25	Roll
2816021	350/700mm	450m	25	Roll
2816024	450/900mm	450m	25	Roll
2816167	400/800mm	450m	25	Roll
2816172	650/1300mm	300m	38	Roll
2816173	750/1500mm	300m	38	Roll

**Polyolefin Shrink Film Clear**

- Multi-purpose film with exceptional tensile strength
- Tear resistant, high shrinkage performance
- Ideal for the packing of toys, vegetables, fruit, bakery products, cakes and confectionery
- Totally food safe



Item Code	Width	Length	Micron	Unit
2916003	350/700mm	1250m	15	Roll
2916005	300/600mm	1335m	19	Roll
2916006	450/900mm	1335m	15	Roll
2916007	450/900mm	1070m	19	Roll
2916008	200/400mm	1075m	19	Roll
2916009	200/400mm	1335m	15	Roll
2916010	500/1000mm	800m	25	Roll
2916011	400/800mm	1000m	19	Roll
2916012	400/800mm	1250m	15	Roll
2916013	500/1000mm	1250m	15	Roll
2916014	250/500mm	1250m	15	Roll
2916015	350/700mm	1335m	15	Roll
2916016	450/900mm	1335m	15	Roll
2916017	550/1100mm	1335m	15	Roll
2916018	400/800mm	800m	25	Roll
2916019	300/600mm	800m	25	Roll
2916020	550/1100mm	800m	25	Roll
2916022	450/900mm	1250m	15	Roll
2916023	500/1000mm	800m	25	Roll

## Polypropylene Machine Strapping

Item Code	Size	Core Size	Colour	Strain
5216023	5mm x 0.4mm x 6000m	150 x 160mm	White	55kg
5216011	5mm x 0.4mm x 6500m	200 x 190mm	White	60kg
5216014	7mm x 0.63mm x 5000m	200 x 190mm	Blue	100kg
5216002	9mm x 0.55mm x 4000m	200 x 190mm	Blue	110kg
5216003	9mm x 0.55mm x 4000m	200 x 190mm	White	110kg
5216006	12mm x 0.55mm x 2500m	200 x 190mm	White	145kg
5216020	12mm x 0.55mm x 3000m	200 x 190mm	Black	145kg
5216007	12mm x 0.55mm x 3000m	200 x 190mm	White	145kg
5216008	12mm x 0.55mm x 3000m	200 x 190mm	Blue	145kg
5216005	12mm x 0.63mm x 2500m	200 x 190mm	White	150kg
5216009	12mm x 0.63mm x 3000m	200 x 190mm	Blue	170kg
5216022	12mm x 0.63mm x 3000m	200 x 190mm	Black	165kg
5216024	12mm x 0.85mm x 1800m	406 x 150mm	Black	255kg



Ask us about bespoke branded strapping featuring your company name, logo or message

## Polypropylene Hand Strapping

- Supplied on a plastic reel



Item Code	Size	Colour	Strain
5116007	12mm x 0.55mm x 2000m	Black	130kg
5116010	12mm x 0.7mm x 1500m	Black	180kg
5116005	12mm x 0.9mm x 1000m	Blue	300kg
5116013	12mm x 0.9mm x 1000m	Black	300kg
5116006	16mm x 0.8mm x 800m	Blue	320kg
5116014	12mm x 0.8mm x 1300m	Black	220kg
5116016	12mm x 0.9mm x 1000m	Yellow	300kg
5116017	15mm x 0.75mm x 1200m	Black	250kg
5116018	15mm x 0.85mm x 1000m	Black	300kg

Need different sizes or colours?  
Ask our sales advisors

## Polyester Bale Strapping



Item Code	Size	Colour	Strain
5516002	9mm x 500m	White	280kg
5516003	13mm x 500m	White	375kg
5516001	16mm x 425m	White	450kg
5516004	16mm x 250m	White	450kg

## Polyester (PET) Strapping

- PET strap is up to 6 times lighter than steel strap
- Highly dense and split resistant
- Excellent weldability
- Good for heavy applications and high tension
- Cardboard core (except 018 & 019 - plastic reel)
- 047, 019 and 044 are embossed strapping



Item Code	Size	Colour	Strain
5416047	12mm x 0.5mm x 2500m	Green	250kg
5416018	12.5mm x 0.55mm x 1600m	Green	270kg
5416012	12.5mm x 0.7mm x 2000m	Green	350kg
5416019	15.5mm x 0.7mm x 1200m	Green	440kg
5416044	15.5mm x 0.85mm x 1500m	Green	550kg
5416017	19mm x 0.8mm x 1200m	Green	620kg

## Woven (PET) Strapping

- PET strap is up to 6 times lighter than steel strap
- Highly dense and split resistant
- Excellent weldability
- Good for heavy applications and high tension
- Woven PET offers a higher resistance to chafing



Item Code	Size	Colour	Strain
5416008	16mm x 850m Hotmelt	White	450kg
5416023	32mm x 300m Woven	White	1400kg
5416026	16mm x 850m Woven	White	450kg
5416027	16mm x 600m Woven	White	600kg
5416029	19mm x 500m Woven	White	725kg
5416030	19mm x 500m Woven	White	1100kg



See strapping trolleys on page 70

**Stainless Steel Strapping**

- Grade 201 stainless strapping, ribbon wound



Item Code	Size	Wound
5816012	12mm x 0.7mm x 30m	Ribbon
5816019	16mm x 0.7mm x 30m	Ribbon
5816013	19mm x 0.7mm x 30m	Ribbon

**Metal Strapping Seals**

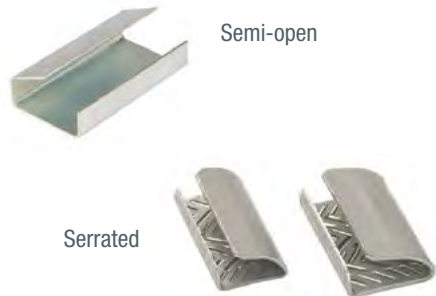

Item Code	Type	Size	Unit
5916047	Serrated	12 x 30mm	Box 1000
5916048	Serrated	16 x 30mm	Box 1000
5916050	Semi-open	12 x 32mm	Box 2000
5916054	Semi-open	12 x 25mm	Box 2000
5916052	Semi-open	16 x 32mm	Box 2000

**Steel Strapping**

- Ribbon wound



- Mill wound

Item Code	Size	Wound	Strain
5816001	13mm x 0.5mm x 1010m	Mill	570kg
5816002	16mm x 0.5mm x 800m	Mill	730kg
5816003	19mm x 0.5mm x 675m	Mill	870kg
5816004	13mm x 0.5mm x 320m	Ribbon	560kg
5816005	16mm x 0.5mm x 332m	Ribbon	720kg
5816007	19mm x 0.5mm x 395m	Ribbon	850kg



Find strapping kits and tools starting on page 71

**Buckles for Strapping**

- Plastic buckles for manual strapping
- Standard or heavy-duty plastic
- Galvanised and sheradised metal buckles
- Stainless steel metal buckles



**Plastic for Manual Strapping**

Item Code	Type	Size	Unit
5916028	White Plastic HD	12mm	Box 1000
5916042	White Plastic	12mm	Box 1000
5916043	Black Plastic	12mm	Box 1000
5916044	Black Plastic HD	12mm	Box 1000

**Stainless Steel**

Item Code	Type	Size	Unit
5916026	Knockdown	12mm	Box 100
5916027	Knockdown	19mm	Box 100

**Galvanised**

Item Code	Type	Size	Unit
5916031	CB Buckle	13mm	Box 1000
5916032	Sheradised	13mm	Box 1000
5916033	CB Buckle	16mm	Box 1000
5916034	Sheradised	16mm	Box 1000
5916035	CB Buckle	19mm	Box 1000
5916036	Sheradised	19mm	Box 1000
5916037	CB Buckle	25mm	Box 500
5916038	Sheradised	25mm	Box 400
5916029	CB Buckle	35mm	Box 250
5916030	Sheradised	35mm	Box 1000

**Polypropylene Twine**

- Polyprop twine for securing packaging



Item Code	Length	Colour	Unit
5316001	700m	White	Each
5316002	450m	White	Each
5316003	280m	White	Each
5316004	170m	White	Each



**CAN'T SEE WHAT YOU'RE LOOKING FOR?**

Give our sales team a call on **08000 540 100**

For updates on products and offers, join our mailing list at [bonustrading.co.uk](http://bonustrading.co.uk)



Custom printed packaging with your logo and branding will help your company stay visible, retain customers and increase repeat orders.

We can print on most packaging, from strapping and boxes to tapes and bags. Just supply your logo or branding info and we'll do the rest.

**Handy Wrap Dispenser**

- Core size: 38mm



Item Code	Description	Unit
1916005	Handy Wrap Dispenser	Each

**Handy Wrap Film**

- Core size: 38mm



Item Code	Size	Colour	Micron	Unit/Box
1916001	80mm x 200m	Clear	15	75 rolls
1916008	100mm x 150m	Clear	17	40 rolls
1916011	100mm x 150m	Clear	17	10 rolls
1916006	100mm x 150m	Black	17	40 rolls
1916009	100mm x 150m	Blue	23	40 rolls
1916007	100mm x 300m	Clear	17	20 rolls
1916010	100mm x 300m	Clear	20	25 rolls

**HD Telescopic Pallet Wrap Dispenser**

- For pallet wrap / stretch film
- Takes core sizes: 38mm; 50mm; 75mm



Item Code	Description	Unit
1216007	Telescopic Pallet Wrap Dispenser	Each

**Gusset Shrink Pallet Bags**

- For loads approx 1200mm in height
- 125 microns, supplied in perforated rolls



Item Code	Load Size (mm)	Cover Size (mm)	Unit
2816006	1200 x 800	1300/2150 x 1850	Roll 30
2816004	1200 x 1000	1300/2350 x 1950	Roll 30
2816005	1200 x 1200	1300/2550 x 2050	Roll 25

**Machine Stretch Film**

- 76mm core
- Approx 16kg rolls



See wrapping machines on page 74



**Optimus® X Film** 

Item Code	Colour	Type	Width	Approx Length	Approx Elongation	Unit
1816041	Clear	Optimus X2S Standard Stretch	500mm	2700m	200%+	Each
1816040	Clear	Optimus X5S Standard Stretch	500mm	2120m	200%+	Each
1816030	Clear	Optimus X2 Power Pre-Stretch	500mm	2700m	250%+	Each
1816031	Clear	Optimus X5 Power Pre-Stretch	500mm	2120m	250%+	Each

**Optimus® Eco Film** 

Item Code	Colour	Type	Width	Approx Length	Approx Elongation	Unit
1816033	Clear	Optimus Eco X7S Standard	500mm	2050m	200%+	Each
1816034	Clear	Optimus Eco XXS Standard	500mm	1740m	200%+	Each
1816035	Clear	Optimus Eco XX3S Standard	500mm	1510m	200%+	Each
1816036	Clear	Optimus Eco X7 Power Pre-Stretch	500mm	2050m	250%+	Each
1816037	Clear	Optimus Eco XX Power Pre-Stretch	500mm	1740m	250%+	Each
1816038	Clear	Optimus Eco XX3 Power Pre-Stretch	500mm	1510m	250%+	Each

**Standard Film**

Item Code	Colour	Type	Micron	Width	Approx Length	Approx Elongation	Unit
1816001	Clear	Standard Cast Stretch	17	500mm	2000m	150%	Each
1816003	Clear	Standard Cast Stretch	20	500mm	1700m	150%	Each
1816006	Clear	Standard Cast Stretch	23	500mm	1500m	150%	Each

**Pre-Stretched Film**

1816002	Clear	Power Pre-Stretch	17	500mm	2000m	250%	Each
1816004	Clear	Power Pre-Stretch	20	500mm	1700m	250%	Each
1816008	Clear	Power Pre-Stretch	23	500mm	1500m	250%	Each
1816007	Black	Power Pre-Stretch	25	500mm	1400m	250%	Each
1816016	Blue Tint	Power Pre-Stretch	23	500mm	1500m	250%	Each
1816017	Blue Tint	Power Pre-Stretch	17	500mm	2000m	250%	Each
1816014	Clear	e-Stretch™ Pre-Stretch	8	450mm	4200m	250%	Each

**BULK BUY OPTIONS AVAILABLE ON MOST PRODUCTS**

**Pallet Wrap**

- High quality range of stretchfilm pallet wrap for manual applications



**Standard Core Wrap**

Item Code	Core	Colour	Type	Micron	Width	Length	Unit
1716010	Std	Clear	Cast Film	17	400mm	300m	6 rolls
1716013	Std	Blue Tint	Cast Film	17	400mm	300m	6 rolls
1716018	Std	Clear	Cast Film	23	400mm	300m	6 rolls
1716039	Std	Opaque Black	Blown Film	17	500mm	250m	6 rolls
1716048	Std	Green Tint	Blown Film	17	400mm	300m	6 rolls
1716049	Std	Red Tint	Blown Film	17	400mm	300m	6 rolls
1716057	Std	Clear	Hand Film e-Stretch™	8	400mm	600m	6 rolls
1716073	Std	Opaque White	Blown Film	23	500mm	250m	6 rolls

**Extended Core Wrap**

1716011	Ext	Clear	Cast Film Ext Core	17	400mm	300m	6 rolls
1716015	Ext	Blue Tint	Cast Film Ext Core	17	400mm	300m	6 rolls
1716019	Ext	Clear	Cast Film Ext Core	23	400mm	300m	6 rolls
1716055	Ext	Black	Blown Film Ext Core	25	500mm	250m	6 rolls

**BULK BUY OPTIONS AVAILABLE ON MOST PRODUCTS**

## Grip® Film

- 8 rolls per box
- 45 boxes per pallet (360 rolls)

Range includes  
30% recycled  
Grip Film Eco



Dispenser not included

- Available in clear, black and colour options  
Colours require min. order of a pallet, 360 rolls

Ask us for a  
demo.  
On-site or  
online.



Item Code	Type	Size	Colour	Unit/Box
1616005	Superior	400mm x 480m	● Black	8 rolls
1616006	Superior	400mm x 480m	● Blue	8 rolls
1616013	Superior	400mm x 480m	● Green	8 rolls
1616014	Superior	400mm x 480m	● Red	8 rolls
1616015	Superior	400mm x 480m	● Yellow	8 rolls
1616016	Superior	400mm x 480m	● Pink	8 rolls
1616017	Superior	400mm x 480m	● Orange	8 rolls
1616018	Superior	400mm x 480m	● Purple	8 rolls
1616004	Premium	400mm x 420m	○ Clear	8 rolls
1616011	Elite	400mm x 550m	○ Clear	8 rolls
1616029	Robust	400mm x 280m	○ White Opaque	8 rolls
1616026	Premium Eco - 30% Recycled	400mm x 420m	○ Clear	8 rolls
1616028	Superior Eco - 30% Recycled	400mm x 480m	○ Clear	8 rolls
1616027	Elite Eco - 30% Recycled	400mm x 550m	○ Clear	8 rolls
1616030	Robust Eco - 30% Recycled	400mm x 280m	● Black Opaque	8 rolls

## Grip® Twist-Lock Dispenser

- Fast and secure locking system
- Lightweight; ergonomic grip handle
- Now magnetic, to keep handy in the warehouse



Item Code	Description	Unit
6616159	Grip Twist-Lock Dispenser	Each

## Grip® Hook

- Alternate storage option for the dispenser



Item Code	Description	Unit
6616157	Grip Hook	Each



See Grip® Film in action  
Watch the video at  
[bonustrading.co.uk](http://bonustrading.co.uk)  
or book a live demo with us.  
We can arrange to visit you or  
carry out the demo via online  
video link.

## Grip® Superior Safety Knife R/hand

- Auto retractable blade
- Die cast metal body



Item Code	Description	Unit
7516064	Grip Safety Knife	Each

**Standard Pistol Grip Dispenser**

- Pistol Grip dispenser for standard tape
- 75mm core



Item Code	Description	Size
1116050	Standard Dispenser	50mm
1116038	Standard Dispenser	75mm

**Heavy Duty Pistol Grip Dispenser**

- Premium heavy duty Pistol Grip with metal frame
- Safety blade cap
- Static suction adjustable grip
- 75mm core



Item Code	Description	Size
1116044	Heavy Duty Dispenser	50mm
1116036	Heavy Duty Dispenser	75mm

**Pistol Grip for Filament Tape**

- Pistol Grip dispenser for use with filament tape
- Coarse toothed blade
- 75mm core



Item Code	Description	Size
1116075	Filament Tape Dispenser	50mm

**Pistol Grip Replacement Blades**

- Pistol Grip dispenser blades
- Filament tape dispenser blades are extra coarse



Item Code	Description	Blades Per Pack/Unit
1116070	50mm Standard	10
1116081	75mm Standard	10
1116083	50mm Heavy Duty	15
1116082	75mm Heavy Duty	10
0216110	50mm Filament Blade	5

Ask us about other dispensers & accessories

**e-tape® Silent Dispenser**

- Retractable Safety Blade
- The ultimate tape dispenser



Item Code	Description	Size
1116022	e-tape Dispenser	50mm
1116063	e-tape Dispenser	75mm



**e-tape® Replacement Blades**



Item Code	Description	Size	Unit
0216004	e-tape Dispenser Blade	50mm	Each
0216121	e-tape Dispenser Blade	75mm	Each

**e-tape® Replacement Wipers**



Item Code	Description	Size	Unit
0216002	e-tape Dispenser Wiper	50mm	Each
0216122	e-tape Dispenser Wiper	75mm	Each

**ZeroTape® Classic Dispenser**

- Ultra light ABS plastic tape dispenser
- Centre of gravity shift
- Ventilated handle
- Smooth apply, cut and release action
- In built silencer
- Spring loaded retractable safety blade
- Change the blade without tools
- For use with ZeroTape tapes



Item Code	Size	Colour
<b>1116078</b>	48mm	Blue
<b>1116079</b>	48mm	Magenta
<b>1116090</b>	72mm	Blue
<b>1116091</b>	72mm	Magenta

Ask us for a demo.  
On-site or online

**ZeroTape® First Dispenser**

- Ergonomically designed
- Lightweight, comfortable centre of gravity shift
- Ultra light ABS plastic tape dispenser
- Smooth apply, cut, and release action
- Ventilated handle
- In built silencer
- Spring loaded retractable safety blade
- Change the blade without tools
- For use with ZeroTape tapes



Item Code	Size	Colour
<b>1116071</b>	48mm	Blue
<b>1116072</b>	48mm	Magenta

**See ZeroTape® in action**  
Watch the video at [bonustrading.co.uk](http://bonustrading.co.uk)  
or book a live demonstration

**ZeroTape® Bundles**

- Bulk buy tape starter bundles - 50mm tape
- With free ZeroTape First dispensers



Ask us about more bundles

Item Code	Rolls	Colour	Dispensers	Unit
<b>0616014</b>	36	Clear	1 First	Each
<b>0616013</b>	36	Brown	1 First	Each
<b>0616007</b>	108	Clear	2 First	Each
<b>0616008</b>	108	Brown	2 First	Each
<b>0616009</b>	180	Clear	3 First	Each
<b>0616010</b>	180	Brown	3 First	Each
<b>0616011</b>	360	Clear	5 First	Each
<b>0616012</b>	360	Brown	5 First	Each

**ZeroTape® Accessories**

- Replacement wipers and blades
- Accessories for ZeroTape dispensers



Item Code	Description	Size	Unit
<b>0616005</b>	ZeroTape Wiper	48mm	1
<b>0616006</b>	ZeroTape Blade	48mm	1

Contact us for 72mm accessories



THE ERGONOMIC TAPE SYSTEM



**Performance Boosting**

Fewer roll changes due to over 2 times the tape length of many standard tapes. Fast and safe blade changes.



**Comfortable**

Reduced operating angle results in less wrist strain. Easy and smooth unwinding. Ventilated handle for better grip.



**Sustainable**

Longer rolls means less packaging waste, minimising your carbon footprint.

**FREE TRIAL**

Ask us about a free no-obligation ZeroTape® trial including dispenser and tape rolls



See the ZeroTape® range of tapes on page 6

**Manual Gummed Paper Tape (WAT) Dispenser**

- Suitable for plain and reinforced gummed tapes up to 76mm in width
- Durable steel side frame construction
- Dispense up to 76cm of tape in one stroke
- Simplified tape length settings
- Easy to use and simple maintenance
- Uniform wetting and clean cutting



Item Code	Description	Weight
1116053	Tape Dispenser - Manual	10kg

Need help choosing manual or electric tape dispensers? Talk to our team for assistance.

**Electric Gummed Paper Tape (WAT) Dispenser**

- Suitable for plain and reinforced gummed tapes up to 76mm in width
- Rugged design, steel frame and ABS casing
- Electronic key pad for pre-determined length, dispensing up to 305cm
- Adjustable heater warms the water, optimising bonding
- UL, CSA and CE approved
- Uniform wetting and clean cutting
- Tape output at 114cm per second



Item Code	Description	Weight
1116054	Tape Dispenser - Electric	13kg



See paper tapes on page 14

**Manual Gummed Paper Tape (WAT) Dispenser**

- Suitable for plain and reinforced gummed paper tapes between 25mm and 76mm in width
- Easy pull handle for variable tape lengths in a single pull
- Up to 91cm of tape in one stroke
- Accommodates up to 305m length tape rolls, max roll diameter is 222mm
- Apex guillotine style cutter for precision cutting
- Hassle free operation and drop-in tape loading
- Large 2ltr water bottle, fewer refills
- Metal chassis and tape feed
- Metric measurements



Item Code	Description	Weight
1116087	Tape Dispenser - Manual	11kg

Ask us for a dispensers demo

**Electric Gummed Paper Tape (WAT) Dispenser**

- Suitable for plain and reinforced gummed paper tapes between 25mm and 76mm in width
- 20 pre-set lengths, programmable repeat long and short
- Dispenses tape at 91cm per second
- Accommodates up to 305m length tape rolls, max roll diameter is 222mm
- Constant warm water for better tape adhesion
- Apex guillotine style cutter for precision cutting
- Easy operation and drop-in tape loading
- Large 2ltr water bottle, fewer refills
- Metal chassis and tape feed
- Metric measurements
- 220/240v ~
- 2.3m long power cord



Item Code	Description	Weight
1116080	Tape Dispenser - Electric	12kg

Find WAT paper tape on page 14

**Floor Tape Applicator 50/100mm**

- Easy-to-use floor taping machine
- Apply marking tape and warning tape on floors
- For tapes up to 100mm in width



Item Code	Description
0416014	Floor Tape Applicator

**Desk Tape Dispenser**

- For 25mm tape on 76mm diameter cores
- Metal construction



Item Code	Description
1116018	Desk Tape Dispenser

**Metal Enclosed Carton Sealer**

- Dispense self adhesive tapes
- Max roll length 66m
- Use with standard 75mm core tapes



Item Code	Tape Width
1116032	25mm
1116085	38mm
1116086	50mm

**Pouch Tape Dispenser**

- Dispenses tape size: 150mm x 66m
- For document enclosed pouch tape
- Robust metal construction



Item Code	Description
1116042	Pouch Tape Dispenser

**Grip® PaperFill Void Fill Dispenser Stand**



- Dispenser stand for Grip PaperFill void fill boxes
- Height adjustable tray, for easy dispensing
- Attach to any workbench, adjustable to any angle
- Robust, high quality, powder coated steel

Item Code	Description
1616020	Grip PaperFill Void Fill Stand
1616019	Grip PaperFill Void Fill Box

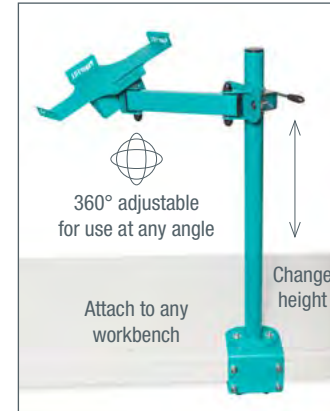

- Easy-open box contains single ply void fill
- Roll 375mm x 350m
- Recycled and recyclable



**Cardboard Shredders**

- Reuse old boxes as void fill and matting
- Reduce plastic void fill use
- 2yr standard warranty
- C400 - desktop shredder, medium capacity, 10mm infeed, single phase (AC)
- P425 - freestanding shredder, high capacity, 20mm infeed, single or three phase options, optional dust vacuum (requires adaptor)



Item Code	Description
6616250	C400 Shredder - Single phase



Item Code	Description
6616251	P425 Shredder - Single Phase
6616252	P425 Shredder - Single Phase + Adaptor
6616253	P425 Shredder - Three Phase
6616254	P425 Shredder - Three Phase + Adaptor
6616255	P425 Shredder Dust Extractor Vacuum



**Papillon Paper Void Fill Machine**

Thanks to its special, patented shape, the paper cushioning of the PAPERplus® Papillon system offers optimal protection for small and medium-sized shipping goods. It's suitable for filling voids and wrapping products, boasts large volume at a low weight, and is especially soft and flexible.

Item Code	Description	Power
6616041	Papillon Void Fill machine	240v ~

Order by 3pm

Next day delivery on all stock items

Which void fill system is best for me?

Call free on 08000 540 100 to speak to our advisers

**Classic Paper Void Fill Machine**

All PAPERplus® Classic models include a programmable and movable control pad to give operators full control of production. Processes rolls of Kraft paper and recycled paper into paper padding for protective packaging of medium-weight to heavy-weight products.

- Nine modes of operation
- Produce pads on-demand or program for multiple stations and/or multiple orders
- Unit lock-out capability
- Continuous adjustable operating speed
- Electronically adjustable machine height
- Touch panel operation
- Effortless mobility for station and set-up changes

Available with table stand or table top stand (bench) or floor stand



Item Code	Description	Power
6616064	Classic Void Fill machine	240v ~

**Void Fill Dispenser**



- Cost effective on-demand void fill for low to medium usage
- Rugged construction
- Can be bench or wall mounted; weighs 6.8kg
- Paper roll braking system prevents over-run
- Integral rip jaws for fast and easy tearing

Item Code	Description	Weight
7716010	Void Fill Dispenser	6.8kg



Ask us about more air pillow solutions, with free machine hire



**AIRplus Excel Air Cushion Machine**



The AIRplus Excel is the ultimate void fill application machine, for the high volume user. Machines supplied free of charge\*

- Takes all film types up to 400mm width
  - High Speed: 18 metres per minute
  - Pre-programmable control panel
- \*subject to contract*

Item Code	Size (LxWxH)	Power
6616001	520 x 480 x 400mm	240v ~

**AIRplus Mini Air Cushion Machine**



Ideal packaging system for void fill applications for the medium volume user. Machines supplied free of charge\*

- Compact design, weighs only 11kgs
  - Takes 200m width film - easy to load
  - Speed: 12 metres per minute
- \*subject to contract*

Item Code	Size (Footprint)	Power
6616002	400 x 300mm	240v ~

**Impulse Heat Sealer**



Need a larger sealer?  
Ask us about other sizes

Spares kits available

- Seal Width: 2mm
- Seals up to 600 Gauge film
- Productivity: 100 seals/shift

Item Code	Seal Length	Power	Weight
6716031	200mm	350W	3.85kg
6716034	300mm	500W	5.00kg
6716037	400mm	750W	5.50kg

**Impulse Heat Sealer with Cutter**



- Seal Width: 2mm
- Seals up to 600 Gauge film
- Productivity: 100 seals/shift

Item Code	Seal Length	Power	Weight
6716032	200mm	350W	3.85kg
6716035	300mm	500W	5.00kg
6716038	400mm	750W	5.50kg

**Tagging Gun & Attachments**



- Lynx AROBEE Extra
- Takes standard and micro-spaced attachments
- Takes regular (DP1) & heavy duty (DM1) needles

Item Code	Description	Unit
9612016	Tagging Gun	Each
9612015	40mm Attachments	5000

**Bag Neck Sealer**



- For sealing plastic bags
- Suitable for 9mm - 12mm tapes
- Durable metal construction
- Can be bench mounted

Item Code	Description	Unit
1116002	Bag Neck Sealer	Each
0116038	Clear polyprop tape 12mmx66m	144 rolls

**Plier Staplers**

- General purpose stapler



Compatible with staples:  
Standard Stapler - S24-6, S24-8, S26-6, S26-8  
Heavy Duty Stapler - S73-8, S73-10, S73-12

Item Code	Description
7216019	Standard Plier Stapler
7216013	Heavy Duty Plier Stapler

**Pneumatic Anvil Staplers**

- Air powered for high volume
- Compresses material for strong tight closure
- Anvils: A (flat), B (stepped straight), CL (stepped left hook), CR (stepped right hook)



Item Code	Description	Weight
7216027	1.27mm Stapler with Type A Anvil	3kg
7216024	2.6mm Stapler with Type A Anvil	3kg
7216025	1.27mm Stapler with A, B, CL & CR	3kg
7216026	2.6mm Stapler with A, B, CL & CR	3kg

**Manual Carton Stapler**

- For securing carton flaps and filled cartons
- Heavy duty construction
- Ideal for high volume carton sealing

Compatible with staples:  
S32-15 - 7216060  
S32-18 - 7216061



Item Code	Description	Weight
7216008	Manual Carton Stapler	2.8kg

See staples on page 67

Join our mailing list

Receive emails with new products, bulk deals and offers.

Join now at [bonustrading.co.uk](http://bonustrading.co.uk)

**Hammer Tacker**

- For fast and easy stapling of labels to crates



Compatible with staples S140-6, S140-8 and S140-10

Item Code	Description
7216010	Hammer Tacker

**Rapid R64 Hand Tacker**

- Suitable for plastic insulation sheet/edging beading
- Adjustable impact force
- Lightweight high-impact ABS plastic construction



Compatible with staples S140-6, S140-8, S140-10, S140-12 and S140-14

Item Code	Description
7216017	R64 Hand tacker

**Rapid Staple Remover**

- Robust staple remover with ergonomic design



Item Code	Description
7216012	Staple Remover

**Treadle Stapler Foot Operated**

- Mechanical treadle action leaves both hands free to accurately align and hold carton



Compatible with staples S32-15 and S32-18

Item Code	Description	Weight
7216030	Treadle Stapler	36.3kg

**Staples**



- Sold per box
- Supplied staples are premium brand Rapid, Stronghold or Stanley Bostitch, unless described differently

Item Code	Size	Description	Staples Per Box/Unit
7216049	6mm	S140-6 staples	5000
7216156	8mm	S140-8 staples	5000
7216042	10mm	S140-10 staples	5000
7216045	12mm	S140-12 staples	5000
7216046	14mm	S140-14 staples	5000
7216058	6mm	S26-6 staples	5000
7216146	8mm	S26-8 staples	5000
7216089	8mm	S24-8 staples	5000
7216060	15mm	S32-15 - use with carton staplers	2000
7216061	18mm	S32-18 - use with carton staplers	2000
7216073	8mm	S73-8 - use with heavy duty staplers	5000
7216069	10mm	S73-10 - use with heavy duty staplers	5000
7216071	12mm	S73-12 - use with heavy duty staplers	5000
7216154	18mm	18x35mm carton staples	2000
7216090	22mm	22x35 carton staples	2000

**Specialist Staples**

Item Code	Size	Description	Staples Per Box/Unit
7216169	9.5mm	Staples for Pneumatic Anvil Staplers (wire width 1.27mm)	5000
7216084	12mm	Staples for Pneumatic Anvil Staplers (wire width 1.27mm)	5000
7216078	12mm	Staples for Pneumatic Anvil Staplers (wire width 2.6mm)	2500
7216080	16mm	Staples for Pneumatic Anvil Staplers (wire width 2.6mm)	2500
7216088	10mm	Arrow A506IP T50 staples	5000
7216068	8mm	Staples for Rapid 105E Electric Pad Stapler	5000
7216092	12mm	5M Galvanised Staples STCR 5019 series	5000
7216144	8mm	Staples for Stanley TR250 stapler	5000
7216145	12mm	JK779-12 Josef Kihlberg staples	5000

**ASK US ABOUT BULK BUY SAVINGS**

**Low Temperature Glue Gun**



- High dispensing accuracy
- Supplied with *Fine/Medium* nozzle
- Other interchangeable nozzle types available
- Removable stand; comfortable long-trigger grip
- Uses 12mm dia. low temp. sticks (*not included*)
- Maximum glue output 8g per minute
- Power supply 240V ~ 80W

Item Code	Description	Weight
<b>7316002</b>	Low Temperature Glue Gun	0.63kg

**Stickfast Light Duty Glue Gun**



- High dispensing accuracy
- Supplied with *Fine/Medium* nozzle
- Other interchangeable nozzle types available
- Removable stand; comfortable long-trigger grip
- Uses 12mm diameter glue sticks (*not included*)
- Maximum glue output 13g per minute
- Power supply 240V ~ 120W;

Item Code	Description	Weight
<b>7316012</b>	Light Duty Glue Gun	0.75kg

**Stickfast Medium Duty Glue Gun**



- High dispensing accuracy
- Supplied with *Standard/Extended* nozzle
- Other interchangeable nozzle types available
- Removable stand; comfortable long-trigger grip
- Uses 12mm diameter glue sticks (*not included*)
- Maximum glue output 25g per minute
- Power supply 240V ~ 300W

Item Code	Description	Weight
<b>7316004</b>	Medium Duty Glue Gun	2.25kg

**Stickfast Heavy Duty Glue Gun**



- High dispensing accuracy
- Supplied with *Standard/Extended* nozzle
- Other interchangeable nozzle types available
- Removable stand; comfortable long-trigger grip
- Uses 18mm diameter glue sticks (*not included*)
- Maximum glue output 42g per minute
- Power supply 240V ~ 600W

Item Code	Description	Weight
<b>7316015</b>	Heavy Duty Glue Gun	2.5kg

**Glue Gun Nozzles**

- Various nozzle sizes for Stickfast glue guns



Item Code	Description	Unit
<b>7516017</b>	Short Nozzle	Each
<b>7516024</b>	Medium/Fine Nozzle	Each
<b>7516019</b>	Extended/Standard Nozzle	Each
<b>7516025</b>	Extended Slim Line Nozzle	Each
<b>7516018</b>	Spreader Nozzle	Each

Need other accessories? Please ask our sales team

**Hot Melt Glue Sticks**

- 300mm length glue sticks
- 43x43mm slugs



Item Code	Description	Diam	Colour	Unit
<b>7316007</b>	Multi Purpose	12mm	Clear	5kg/box
<b>7316028</b>	Multi Purpose	18mm	Clear	5kg/box
<b>7316008</b>	Multi Purpose	43mm	Clear	10kg/box
<b>7316026</b>	Fast Set	12mm	Tan	5kg/box
<b>7316021</b>	Fast Set	18mm	Tan	5kg/box
<b>7316027</b>	Fast Set	43mm	Tan	10kg/box
<b>7316029</b>	High Strength	12mm	Amber	5kg/box
<b>7316023</b>	High Strength	18mm	Amber	5kg/box
<b>7316030</b>	High Strength	43mm	Amber	10kg/box
<b>7316006</b>	Sensitive Materials / Low Temp.	12mm	White	5kg/box

Need different glues? Our sales team can advise

**Mill Wound Strapping Trolley**

- Separate tote for seals and tools
  - 13-16mm strap width adjustment
- Strapping and seals not included*



Item Code	Description	Weight
<b>1316004</b>	Mill Wound Strap Trolley	24kg

**Ribbon Wound Strapping Trolley**

- Separate plastic tote for seals and tools
  - 19-32mm strap width adjustment
- Strapping and seals not included*



Item Code	Description	Weight
<b>1316011</b>	Ribbon Wound Strap Trolley	16.4kg

**Polyprop Strapping Trolley**

- For polyester and polypropylene strapping
  - Compatible with strapping on plastic reels
  - Integral tote holder for holding seals
- Strapping and seals not included*



Item Code	Description	Weight
<b>1316007</b>	Polypropylene Strap Trolley	6.3kg

**Pallet Probe**

- Ideal for feeding strapping under pallets
- Suitable for polyprop, polyester & steel strapping
- 1.4m long, 19mm wide



Item Code	Description	Length	Unit
<b>7016021</b>	Pallet probe	1400mm	Each

**Tensioner/Sealer Kit with Dispenser**



**Kit contents:**  
 Dispenser (1316009); Std Tensioner 7016040  
 12mm Sealer (7016034); 1500m coil of 12mm  
 black strapping (5116010); 500 seals (5916054)

Item Code	Description	Weight
<b>6116020</b>	Polypropylene Strap Trolley	6.3kg

**Tensioner/Sealer Kit with Trolley**



**Kit contents:**  
 Trolley (1316007); Std Tensioner (7016040)  
 & 12mm Sealer (7016034); 1500m coil of 12mm  
 black strapping (5116010); 500 seals (5916054)

Item Code	Description
<b>6116017</b>	Tensioner/Sealer Kit

**Combi Strapping Kit with Trolley**



**Kit contents:**  
 Trolley (1316007); Combination Tool (7016030)  
 1500m coil of 12mm black strapping (5116010);  
 500 seals (5916054)

Item Code	Description	Weight
<b>6116018</b>	Polypropylene Strap Trolley	6.3kg

**Stainless Steel Tensioner**

- High quality tensioning tool for stainless steel strapping
- For use with 12mm and 19mm strapping band



Item Code	Strap Width	Weight
<b>7016043</b>	12mm and 19mm	1.4kg

**HD Polypropylene Tensioner**

- Maximum strap width 19mm
- Good for high strap tension
- Weight 2.2kg



Item Code	Strap Width	Model	Weight
<b>7016036</b>	19mm	HPT	2.2kg

**Std Polypropylene Tensioner**

- General use tensioner; strapping up to 19mm
- Designed for use with semi-open or closed metal seals



Item Code	Strap Width	Model	Weight
<b>7016040</b>	19mm	TST30	1.3kg

**Std Polypropylene Strap Sealer**

- Single notch action releases highly tensioned strap more easily
- Used on semi-open seals



Item Code	Strap Width	Model	Weight
<b>7016034</b>	12mm	SGP12	2.2kg
<b>7016035</b>	16mm	SGP16	2.2kg

**Medium Polypropylene Strap Sealer**

- For strapping small cartons, crates and packages
- Designed for use with semi-open or closed metal seals
- Offset jaws for use on serrated seals



Item Code	Strap Width	Model	Weight
<b>7016014</b>	12mm	KNS12	2.0kg
<b>7016015</b>	16mm	KNS16	2.0kg

**Lightweight Polyprop Combi Tool**

- For use with serrated seals:  
12mm - 5916047  
16mm - 5916048



Item Code	Strap Width	Model	Weight
<b>7016028</b>	12mm	RSK12	4.7kg
<b>7016029</b>	16mm	RSK16	4.8kg

**Std Polypropylene Combi Tool**

- For use with semi-open seals:  
12mm - 5916054  
16mm - 5916052



See strapping seals on page 46

Item Code	Strap Width	Model	Weight
<b>7016030</b>	12mm	SPC12	3.4kg
<b>7016031</b>	16mm	SPC16	3.5kg

**Battery Powered Strapping Tool**



Ask us for a demo. On-site or online

Item Code	Description
<b>7016006</b>	Spare Battery 18V
<b>7016007</b>	Battery Charger

- Friction weld tool
- 18V Li-ion battery included
- Digital touch panel
- Brushless DC motor technology
- Battery and charger included
- Simple adjustment for different size strapping
- Advanced friction weld sealing technology
- Impact resistant robust housing
- Perfect balance & ergonomic design

Item Code	Strap Width	Weight
<b>7016108</b>	11-13mm	4.3kg
<b>7016109</b>	15-16mm	4.3kg
<b>7016111</b>	16-19mm	4.4kg

**Optimus Pallet Wrappers**

- 1650mm diameter turntable, suitable for standard and European size pallets
- Adjustable turntable speed - set your optimum speed
- Cycles include manual, upward-downward, top sheet and self-learning
- Up to 6 program settings on most models
- Height detection photocell, accommodates random height pallets
- Dark sensitive photocell (option) for wrapping with dark films
- Grounding frame available for installation at floor level
- Choice of bases, including low profile or trolley truck slotted
- Ramp options include 1 tonne, 2 tonne and extended versions
- Easy to view, user friendly control panel
- OLED display and membrane controls
- Remote wifi connection (option)
- Emergency stop button
- Power: 240v ~
- Capacity: 2000kg
- Turntable diameter: 1.65m
- Max load size: 1m x 1.2m x 2.2m (height) 2.4m height options are available
- 150M - Standard mechanical brake stretch
- 250E - PPS, 250% power pre-stretch (1m stretch to 3.5m)

Ask us for a free demo

Next day delivery



Model shown: 250E

Lease a machine with no upfront costs!  
Ask us about Zero Cap Ex.

**£ ZERO CAP EX**  
Zero Capital Expenditure

**PAYMENT PLANS AVAILABLE**

**Optimus**

**ORDER NOW!**  
Payment plans available



Multiple ramp and base options to choose from

Item Code	Description
6616171	150M Wrapper - Mechanical Brake
6616173	250E Wrapper - Power Pre-Stretch
6616199	Wrapper Ramp (1 tonne)
6616200	Wrapper Ramp (2 tonne)

Would you also like details about our robot and rotary arm wrappers? Contact our team.

**Shrink Film Gas Cylinder Trolley**

- Heavy duty mobile gas cylinder trolley
- For shrinkwrap systems



Item Code	Description
6516002	Trolley

**Shrink Film Roll Dispenser**

- Lockable castors
- Expands up to 2 metres
- Supplied with one spindle as standard



Item Code	Description
6516005	(HxWxD) 870 x 2000 x 660mm
6516014	Additional Spindle for above

**Gas Shrink Wrap Gun**



- Low cost system
- Includes 8m hose and safety regulator valve.
- 32kw
- Uses propane gas (not supplied)

Item Code	Description	Weight
6516001	Shrink Wrap Gun	1kg

**Ripack Shrink Wrap Guns**



R2200 - 68kw	6516004
R3000 - 78kw	6516015

- Can shrink wrap a pallet in under 2 minutes
- Up to 20% more productivity
- Instantaneous - smooth ignition
- Patented swivelling cold nozzle
- Double safety regulator • 8m hose

Item Code	Description
6516004	Ripack 2200 Shrink Wrap Gun
6516015	Ripack 3000 Shrink Wrap Gun



### Heat Shrink Chamber 346

- Very low energy consumption
- Advanced electronic controls
- Max film width: 400mm
- Max sealing dimensions: 320 x 460mm
- Max package height: 120mm
- Supplied with mobile stand

Item Code	Machine Size (WxDxH)	Power
6616061	1120 x 660 x 550mm	240v ~

Ask for a site survey



Call free on  
**08000 540 100**  
to speak to our advisers



Join our mailing list

Receive emails with new products, bulk deals and offers.

Join now at  
**bonustrading.co.uk**



### Heat Shrink Chamber 455

- Very low energy consumption
- Advanced electronic controls
- Max film width: 600mm
- Max sealing dimensions: 420 x 550mm
- Max package height: 250mm
- Supplied with mobile stand

Item Code	Machine Size (WxDxH)	Power
6616062	1320 x 820 x 645mm	240v ~



### Automatic Strapping 600

- Designed for high volume automated strapping
- 27 straps/min
- External tension control; 10-70kg
- Short feed sensor to prevent misfeeds
- Strap width: 9 -15.5mm
- Arch size: 850 x 600mm

*Other arch sizes are available to suit your requirements*

Item Code	Size (WxDxH)	Power
6616017	1430 x 620 x 1540mm	240v ~

Ask us about bespoke branded strapping featuring your company name, logo or message.  
See page 48

### Semi Automatic Strapping 200



- External mounted strap coil
- Manual strap tension adjustment
- Reliable control head
- Adjustable mobile table height
- Braking swivel castors

Item Code	Size (WxDxH)	Power
6616063	910 x 585 x 730-900mm	240v ~

### Semi Automatic Strapping 300



- Offers a quick and efficient method of strapping single or multiple packages of varying sizes
- External tension control: 15-45kg
- Strap Width: 6 - 15.5mm
- Strapping speed: 2.5 sec/cycle (60Hz)

Item Code	Size (WxDxH)	Power
6616016	920 x 595 x 785mm	240v ~

**Flexible Warehouse Trolley**



- Adjustable-height electro galvanised shelves
- Adjustable handle
- 2 fixed 2 swivel castors
- Shelf size: 1200 x 600mm

Item Code	Size (LxWxH)	Capacity
<b>1049042</b>	1390 x 650 x 1695mm	300kg

**Pallet Truck 2500kg**



- Ideal for standard pallets - Euro and GKN
- Nylon non-slip wheels
- Nett Weight: 70kg

Item Code	Description	Capacity
<b>1049044</b>	Pallet Truck	2500kg

**Economy Packing Station**



Saves space and time packing goods, with storage facility for cartons, wrappings and equipment

- Sturdy welded steel section construction
- Supplied flat-packed

Item Code	Size (WxDxH)	Weight
<b>7716018</b>	1800 x 780 x 1500mm	68kg

**Packing Table**



Improve efficiency. Ask us for a packing station review

- Powder coated steel frame construction
- 75-90cm adjustable bench height
- Laminated MDF work surface

*Up to 2 extra shelves can be fitted to this table. Please ask for further details.*

Item Code	Size (LxW)
<b>7716018</b>	1600 x 800mm

**Automatic Case Taper**

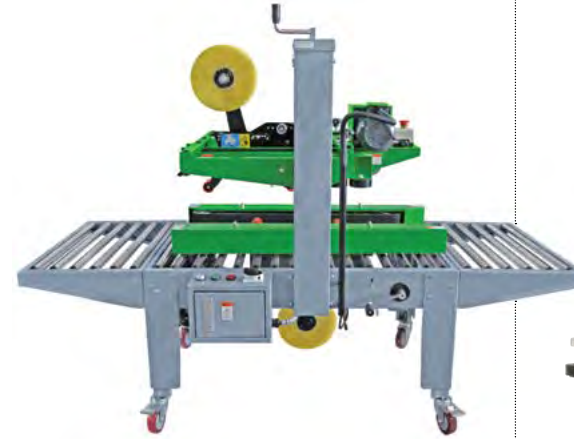

1800 Boxes/Hour

For machine tape see page 8

- Ideal for use where large quantities of cases need to be sealed
- Simultaneous top and bottom carton flap sealing
- Adjustable leg height and lockable swivel castors
- Infeed and outfeed roller conveyors
- Tape size: 48-75mm
- Min/max carton width: 120-480mm
- Min/max carton height: 120-480mm
- Min/max carton length: 150-500mm
- Power: 600W

*System capable of detecting assorted box sizes can be integrated into your packing operations. Additional safety guards fitted on request.*

Item Code	Size (LxWxH)	Power
<b>6616007</b>	1090 x 890 x 1280mm	240v ~

**Semi-Automatic Case Taper**



800 Boxes/Hour

- Best suited to batch sealing of uniform-sized cartons
- Simultaneous top and bottom carton flap sealing
- Manual upper sealing head height adjustment
- Adjustable leg height and lockable swivel castors
- Infeed and outfeed roller conveyors
- Upper and lower 50mm wide tape heads
- Min/max carton width: 150-500mm
- Min/max carton height: 120-500mm
- Min/max carton length: 120mm-unlimited
- Belt speed 23 metres per minute
- Power: 450W

*75mm wide tape heads available on request. Additional safety guards fitted on request.*

Item Code	Size (LxWxH)	Power
<b>6616060</b>	1637 x 756 x 1375mm	240v ~

## Snap-off Blade Knives

- Lockable blade
- Lightweight plastic housing



## Item Code Description

**7516029** 18mm Snap-off Blade Knife

**7516025** 9mm Snap-off Blade Knife

## Safety Knives



- BNR (Red) right-handed safety cutter
- BNL (Yellow) left-handed safety cutter
- Supplied with standard blade
- Blade automatically retracts when contact is lost

## Item Code Description

**7516016** Safety Knife Right Hand

**7516015** Safety Knife Left Hand

## Metal Retractable Knife

- Durable general use MRK cutter



## Item Code Description

**7516031** MRK cutter

## Anti-stab Retractable Safety Knife



- BNR (right-handed) and BNL (left-handed) knives
- Supplied with anti-stab rounded edge blade
- Blade automatically retracts when contact is lost

## Item Code Description

**7516043** Anti-stab Safety Knife Right Hand

**7516045** Anti-stab Safety Knife Left Hand

## Cruze Cutter Safety Knife



- Box & Film Cutter with safety blade
- Larger thumbnail cutter for piercing tape without damaging carton contents
- Concealed blade for increased safety
- Thumb rest for ergonomic comfort and control
- Embossed body texture for extra grip
- Curved leading edge to prevent stretch cutter snagging on ridges
- Tapered profile separates stretch film from pallet
- Clip on the side for attachment to workwear



## Item Code Description

**7516034** Cruze Cutter

## Stretch Film Cutter



- For cutting stretch film, shrink film and bubble wrap

## Item Code Description

**7516020** Stretch Film Cutter

## Box Cutter



- For cutting stretch film and bubble wrap
- Hook blade for opening cartons

## Item Code Description

**7516017** Box Cutter

**Knife Blades**



Item Code	Description	Blades Per Pack/Unit
7516002	Blades - for ACK, CHS, FET & EST cutters	10
7516008	18mm Snap-off Blades - for CPK18 & MDC18	10
7516009	9mm Snap-off Blades - for CPK9 & LDK9	25
7516011	Knife Blades - standard retractable blades - for MRK	5
7516012	Knife Blades - standard retractable blades - for MRK - bulk pack	100
7516004	Knife Blades - for BNR & BNL safety knives	10
7516042	Rounded Edge Knife Blades - for BNR & BNL safety knives	10

**Knife Lanyards**

- Use with most knives with lanyard holes



Item Code	Description
7516026	Plastic Lanyard
7516030	Metal Retractable Lanyard

**Ratchet Straps**

- Hook ratchet straps



Item Code	Width	Length	Max Strain	Unit
2416006	50mm	6m	5000kg	Each
2416023	25mm	8m	700kg	Each

**Hand Towel**



Item Code	Description	Colour	Unit
2216008	C-fold Hand Towel 1-ply	Green	2700
2216013	Z-fold Hand Towel 2-ply	White	3000
2216010	Centre-feed Roll 2-ply	Blue	6
2216011	Centre-feed Roll 2-ply	White	6
2216082	Centre-feed Roll 1-ply	Blue	6
2216002	Mini Centre-feed Roll	Blue	12



**Hand Towel Dispensers**



Item Code	Description	Colour	Unit
2216004	Centre-feed Dispenser	White	Each
2216005	C-fold / Z-fold Dispenser	White	Each
2216007	Mini Centre Feed Dispenser	White	Each

**Toilet Tissue**



- 2216006 and 2216027 have 75mm/3" core
- All are 2-ply white tissue

Item Code	Roll length	Colour	Unit
2216012	280 sheets, Luxury	White	40
2216024	280 sheets, Economy	White	36
2216020	150m Mini Jumbo	White	12
2216027	300m Jumbo	White	6
2216006	400m Jumbo	White	6

**Handling Gloves**

- Vinyl dots or palms for excellent grip
- Thermal gloves have red dots



Item Code	Description	Size	Unit
2316032	Handling Gloves (Dots)	S/7	Pair
2316024	Handling Gloves (Dots)	M/8	Pair
2316007	Handling Gloves (Dots)	L/9	Pair
2316045	Handling Gloves (Dots)	XL/10	Pair
2316006	Thermal Handling Gloves	M/8	Pair
2316040	Grip Gloves - Yellow	L/9	Pair

**Grey Knitted PU Nylon Gloves**

- Good grip and comfort
- Ideal for packing and assembly



Item Code	Description	Size	Unit
2316195	Nylon Gloves	XS/6	Pair
2316054	Nylon Gloves	S/7	Pair
2316055	Nylon Gloves	M/8	Pair
2316048	Nylon Gloves	L/9	Pair
2316051	Nylon Gloves	XL/10	Pair
2316052	Nylon Gloves	XXL/11	Pair

**Cut Resistant Gloves**

- PU coated cut level D gloves
- High level of cut resistance, HPPE grey knit
- Sold in packs of 12 pairs



Item Code	Description	Size	Unit
2316046	Cut Resistant Gloves	S/7	Pair
2316343	Cut Resistant Gloves	M/8	Pair
2316344	Cut Resistant Gloves	L/9	Pair
2316345	Cut Resistant Gloves	XL/10	Pair

**Hi-Vis Bomber Jacket**



Item Code	Colour	Size	Unit
2316132	Yellow	M	Each
2316133	Yellow	L	Each
2316134	Yellow	XL	Each

**Nitrile Gloves**

- Powder free
- Latex and protein free



Item Code	Colour	Size	Unit
2316156	Blue	S/7	100
2316157	Blue	M/8	100
2316158	Blue	L/9	100
2316159	Blue	XL/10	100

**Vinyl Gloves**

- Powder and latex free
- Non sterile, non allergenic



Item Code	Colour	Size	Unit
2316154	Clear	S/7	100
2316162	Clear	M/8	100
2316163	Clear	L/9	100
2316164	Clear	XL/10	100

**Hi-Vis Vest Yellow**



Item Code	Colour	Size	Unit
2316020	Yellow	S	Each
2316019	Yellow	M	Each
2316018	Yellow	L	Each
2316021	Yellow	XL	Each
2316141	Yellow	XXL	Each
2316160	Yellow	XXXL	Each

**Hi-Vis Vest Orange**

- Flame retardant



Item Code	Colour	Size	Unit
2316114	Orange	S	Each
2316115	Orange	M	Each
2316116	Orange	L	Each
2316117	Orange	XL	Each
2316118	Orange	XXL	Each

**Reinforced Parcel Tags**

- Strung or unstrung
- Manilla tags
- Coloured tags



Item Code	Size	Colour	Type	Strung	Unit
9612006	56 x 35mm	Manilla	Tag	✓	1000
9612007	56 x 35mm	Manilla	Tag		1000
9612008	70 x 35mm	Manilla	Tag	✓	1000
9612009	70 x 35mm	Manilla	Tag		1000
9612010	82 x 41mm	Manilla	Tag	✓	1000
9612011	82 x 41mm	Manilla	Tag		1000
9612012	96 x 48mm	Manilla	Tag	✓	1000
9612014	96 x 48mm	Manilla	Tag		1000
9612017	108 x 54mm	Manilla	Tag	✓	1000
9612018	108 x 54mm	Manilla	Tag		1000
9612019	120 x 60mm	Manilla	Tag	✓	1000
9612026	120 x 60mm	Manilla	Tag		1000
9612020	120 x 60mm	Blue	Tag	✓	250
9612021	120 x 60mm	Green	Tag	✓	250
9612022	120 x 60mm	Pink	Tag	✓	250
9612023	120 x 60mm	Red	Tag	✓	250
9612024	120 x 60mm	White	Tag	✓	250
9612025	120 x 60mm	Yellow	Tag	✓	250
9612027	134 x 67mm	Manilla	Tag	✓	1000
9612028	134 x 67mm	Manilla	Tag		1000

**BULK BUY SAVINGS AVAILABLE ON MOST LABELS ITEMS**

**e-label Direct Thermal Portable A30L & A40L**



- Print speed: 127mm (5") per second
- Resolution: 8 dots/mm (203dpi)
- IP54-rated protective case to resist dust & water
- Highly durable case design for drop protection
- Wired & wireless communication interfaces: USB 2.0, MFi Bluetooth 5.0 or 802.11 a/b/g/n/ac Wi-Fi with Bluetooth 4.2 combo module
- High capacity rechargeable Li-on batteries

- Integrated solutions software for iOS, Android and others
- 2.3" colour LCD display
- Monitor smart battery and print head status
- 128MB SDRAM and 128MB Flash memory
- MicroSD reader, memory expansion to 32GB
- Built-in peeler or linerless kit option available
- Accepts standard cores and 19mm core with adapter

**Portable A30L**

- Max label width: 80mm (3.15")
- Max print width: 72mm (2.8")
- Rechargeable Li-on battery 3030mAh
- Weight 745g

Item Code	Model	DPI
8012173	A30L	203

**Portable A40L**

- Max label width: 112mm (4.4")
- Max print width: 104mm (4.1")
- Rechargeable Li-on battery 6200mAh
- Weight 1kg

Item Code	Model	DPI
8012174	A40L	203

Accessories for portable printers include protective cases, shoulder straps, belt clips, vehicle mounts and spare batteries. Contact our sales team for more details

**e-label Direct Thermal Desktop**



- Print speed: 152mm (6") per second
- Resolution: 8 dots/mm (203dpi)
- Max print width: 108mm (4¼")
- High quality double-walled clamshell design
- Easy media loading
- USB 2.0 (High speed mode)
- Versatile TSPL-EZD firmware
- Bluetooth 4.0
- 16MB DRAM and 8MB Flash memory

**e-label EL240T & EL340T**



- Thermal transfer & direct thermal printing
- Print speed (EL240T): 203mm (8") per sec
- Print speed (EL340T): 152mm (6") per sec
- Resolution (EL240T): 8 dots/mm (203dpi)
- Resolution (EL340T): 12 dots/mm (300dpi)
- Max print width (EL240T): 108mm (4¼")
- Max print width (EL340T): 105.7mm (4.16")
- Die cast metal cover
- Easy to use 3.5" touch colour GUI display and intuitive indicators
- Standard USB, USB Host, Serial & Internal Ethernet
- Versatile TSPL-EZD firmware
- Bluetooth 4.2
- 128MB SDRAM and 128MB Flash memory

Item Code	Model	DPI
8012123	DT Desktop	203

Item Code	Model	DPI
8012150	EL240T	203
8012152	EL340T	300



**Not sure which printer you need?**

Call us to talk to our expert product advisors and they will explain your options



**Printer Maintenance**

We can keep your printers running smoothly with regular maintenance. Get in touch for details and a quote

# BESPOKE CUSTOM LABELS

Quality labels made to suit your needs and your products

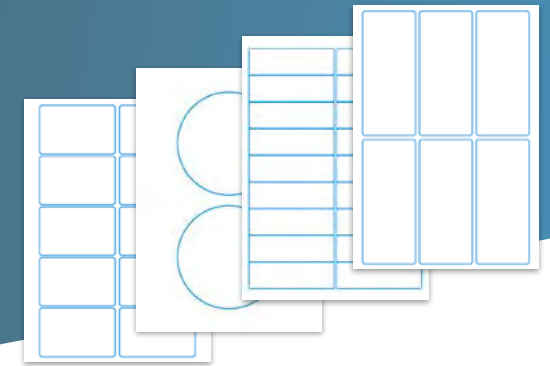

We can design and supply bespoke labels - custom printed and sized to your requirements.

Labels that feature your logo and branding will help your company stay visible, retain customers and increase brand awareness.

All of our label options can be supplied in bespoke sizes and/or custom printed, including roll labels and sheet labels. Just send us your logo or brand details and we'll do the rest.

**FREE**  
custom designing  
and artwork

## Direct Thermal Labels for Industrial Printers

- Zebra compatible
- No ribbon required
- 76mm core diameter
- Permanent adhesive



**Uncoated** Permanent adhesive, 76mm core, for industrial printers

Item Code	Size (WxH) mm	Labels per roll	Rolls per box	Perforated	Roll dia mm
8612010	51 x 25	5860	10		200
8612011	51 x 32	4790	10		200
8612012	57 x 32	4470	8		200
8612013	70 x 32	4470	8		200
8612014	76 x 25	5180	6		200
8612015	76 x 152	3100	6	✓	200
8612016	102 x 38	4050	4		200
8612017	102 x 64	2510	4		200
8612018	102 x 76	2110	4		200
8612019	102 x 102	1432	4		200
8612020	102 x 152	950	4		200
8612021	102 x 152	950	4	✓	200
8612022	102 x 165	990	4		200
8612023	100 x 150	1020	4		200
8612024	100 x 210	810	4		200
8612025	148 x 210	790	4		200
8612026	148 x 210	790	4	✓	200
8612027	76 x 51	3100	4	✓	200
8612028	100 x 50	3000	4		200

## Direct Thermal Labels for Desktop Printers

- Zebra compatible
- No ribbon required
- 25mm core diameter
- Permanent adhesive



**Topcoated** Permanent adhesive, 25mm core, for desktop printers

Item Code	Size (WxH) mm	Labels per roll	Rolls per box	Perforated	Roll dia mm
8612029	25 x 76	930	12	✓	127
8612030	31 x 22	2780	12	✓	127
8612031	32 x 25	2580	12	✓	127
8612032	51 x 25	2580	12	✓	127
8612033	57 x 19	3315	12	✓	127
8612034	57 x 32	2100	12	✓	127
8612035	57 x 51	1370	12	✓	127
8612036	57 x 76	930	12	✓	127
8612037	57 x 102	700	12	✓	127
8612038	76 x 25	2580	12	✓	127
8612039	76 x 51	1370	12	✓	127
8612040	100 x 50	1300	4		127
8612041	102 x 25	2580	12	✓	127
8612042	102 x 38	1790	12	✓	127
8612043	102 x 64	1100	12	✓	127
8612044	102 x 76	930	12	✓	127
8612045	102 x 102	700	12	✓	127
8612046	102 x 127	565	12	✓	127
8612047	102 x 152	475	12	✓	127

**Thermal Transfer Labels**

- For mid-range and high-end printers
- Needs ribbons
- 76mm core diameter
- Permanent adhesive
- Other sizes available
- Removable labels available



Many more sizes in stock. Ask for details

**Matt Coated** Permanent adhesive, 76mm core, for mid range and high end printers

Item Code	Size (WxH) mm	Labels per roll	Rolls per box	Perforated	Roll dia mm
8512013	38 x 19	6742	10		200
8512014	38 x 25	5180	10		200
8512015	51 x 25	5180	10		200
8512016	51 x 32	4240	10		200
8512017	57 x 19	7995	4		200
8512018	57 x 32	5087	4	✓	200
8512019	64 x 24	5180	8		200
8512020	70 x 32	4240	8		200
8512021	76 x 51	2740	6		200
8512022	76 x 51	3292	4	✓	200
8512023	76 x 76	1890	6		200
8512024	83 x 140	1040	6		200
8512025	89 x 25	5180	6		200
8512026	102 x 38	3634	4		200
8512027	102 x 38	4225	4	✓	200
8512028	102 x 51	2740	4		200
8512029	102 x 64	2220	4		200
8512030	102 x 76	2238	4	✓	200
8512031	102 x 102	1432	4		200
8512032	102 x 127	1152	4		200
8512033	102 x 152	950	4		200
8512034	102 x 152	1142	4	✓	200
8512035	102 x 203	726	4		200
8512036	148 x 210	700	4		200

**Thermal Transfer Ribbons**

- Compatible with most leading makes of printer
- Standard colour: Black
- Other colours available
- Other sizes available



We also stock genuine ribbons for some models

Order by 3pm

Next day delivery on all stock items

**Compatible Ribbons Outside Wound**

Item Code	Width mm	Roll Length m	Rolls per box	Type	Colour
8112078	80	450	10	Wax/Resin	Black
8112079	110	450	10	Wax/Resin	Black
8112098	50	450	10	Wax	Black
8112099	80	450	10	Wax	Black
8112101	104	450	10	Wax	Black
8112102	110	450	10	Wax	Black
8112104	130	450	10	Wax	Black
8112106	155	450	10	Wax	Black

**Compatible Ribbons Inside Wound**

Item Code	Width mm	Roll Length m	Rolls per box	Type	Colour
8112074	76	360	10	Wax/Resin	Black
8112075	104	360	10	Wax/Resin	Black
8112076	114	360	10	Wax/Resin	Black
8112088	50	360	10	Wax	Black
8112089	76	360	10	Wax	Black
8112092	104	360	10	Wax	Black
8112094	114	360	10	Wax	Black
8112103	110	450	10	Wax	Black
8112105	155	450	10	Wax	Black
8112107	165	450	10	Wax	Black

**Parcel & Carton Labels**



**Size (WxH): 79 x 108mm**

Item Code	Printed Message	Labels per roll
9112007	FRAGILE/HANDLE WITH CARE	500
9112009	FRAGILE	500
9112011	HANDLE WITH CARE	500
9112017	DO NOT STACK	500
9112018	THIS WAY UP	500

**Size (WxH): 148 x 50mm**

Item Code	Printed Message	Labels per roll
9112021	FRAGILE	500
9112022	GLASS WITH CARE	500
9112023	HANDLE WITH CARE	500
9112025	CAUTION HEAVY PACKAGE	500
9112033	THIS WAY UP	500

**Size (WxH): 89 x 32mm**

Item Code	Printed Message	Labels per roll
9112037	DO NOT BEND	1000
9112038	DOCUMENTS ENCLOSED	1000
9112039	FRAGILE	1000
9112040	GLASS	1000
9112041	HANDLE WITH CARE	1000

Many more different labels in stock. Please ask our team for details



Next day delivery on all stock items

**Label Dispensers Manual**



- Rubber anti-slip feet
- Can be bench or wall mounted

Item Code	Working Width
1416006	100mm
1416009	165mm
1416010	200mm
1416008	265mm

**Label Applicators Hand-held**

Hand-held label applicators that automatically adjust to any size die-cut label. Mechanical sensors allow only one label at a time to be dispensed with just one squeeze of the trigger.



Item Code	Working Width
1416001	100mm
1416002	30mm
1416003	60mm

**Sealing Labels**

A perfect solution for secure sealing on promotional material, mailshots, merchandise and confidential documentation

**Available Colours**



\* Available on 9512005.  
Add suffix **S** for Silver; **G** for Gold.  
Minimum Order: 2000 labels.

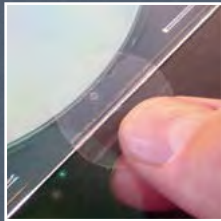

Item Code	Size (WxH) mm	Labels per roll	Rolls per box	Type
9512025	12 dia	1000	5	Permanent
9512004	19 dia	1000	2	Permanent
9512005	25 dia	1000	1	Permanent
9512028	25 dia	1000	1	Removable
9512029	25 dia	1000	1	Perforated
9512030	32 dia	1000	1	Permanent
9512006	38 dia	1000	1	Permanent
9512033	45 dia	1000	1	Permanent
9512034	45 dia	1000	1	Removable
9512035	45 dia	1000	1	Perforated
9512036	50 dia	1000	1	Permanent
9512037	50 dia	1000	1	Removable
9512007	60 dia	1000	1	Permanent
9512038	60 dia	1000	1	Removable
9512039	30 x 12	1000	2	Permanent
9512040	30 x 12	1000	2	Removable
9512021	50 x 20	1000	2	Permanent
9512041	50 x 20	1000	2	Removable
9512042	74 x 30	1000	2	Permanent
9512043	74 x 30	1000	2	Removable

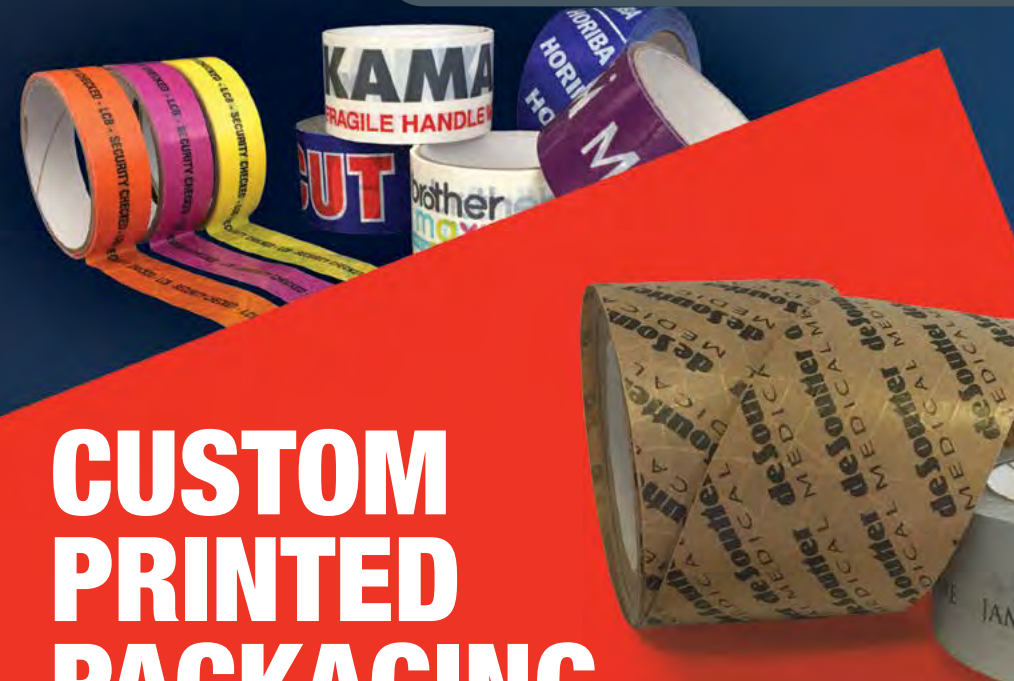

# CUSTOM PRINTED PACKAGING

- Paper Tape
- Poly Tape
- Vinyl Tape
- Floor Tape
- Sheet Labels
- Roll Labels
- Fanfold Labels
- Mailing Bags
- Boxes, Card & Papers
- Strapping
- Document Envelopes
- Poly Bags

[bonustrading.co.uk](http://bonustrading.co.uk)

[bonustrading.co.uk](http://bonustrading.co.uk)

**BONUS**

**BONUS**

**BONUS**

**BONUS**

Custom printing can help you build a stronger brand, stay memorable and increase repeat orders. Printed packaging can also be functional. For example, your boxes, bags, tapes and labels can carry information, caution icons or checkboxes, making stock management and delivery more efficient.

**BONUS**

**e-label® A4 Sheet Labels**

Our A4 Digital Office range uses only the highest quality laser grade materials to ensure jam-free, smooth running and maximum output.

- Premium labels
- Square cornered labels butted together
- Radius corners, with a selvage around the edge



**Rectangles** Boxed 500 Sheets - Standard - White

Item Code	Size (WxH) mm	Labels/sheet	Type
8712019	210 x 297	1	BC
8712022	199.6 x 289.1	1	SE
8712030	200 x 120	2	SE
8712036	210 x 148.5	2	BC
8712037	200 x 144	2	SE
8712043	105 x 148.5	4	BC
8712047	99 x 139	4	SE
8712054	99.1 x 93.1	6	SE
8712055	105 x 74	8	BC
8712057	99 x 68	8	SE
8712002	105 x 57.75	10	BC
8712003	99 x 57	10	SE
8712004	105 x 50	12	BC
8712009	105 x 35	16	BC
8712096	105 x 37	16	BC
8712026	64 x 38.1	21	SE

**Circles** Boxed 500 Sheets - Premium - White

Item Code	Size mm	Labels/sheet	Type
8712110	116 diameter	2	SE
8712111	63.5 diameter	12	SE
8712112	38.1 diameter	20	SE

+ 40mm diagonal split back

Premium labels

**Available Colours**



Ask us about coloured labels

Other papers, polyester and Teslin materials available on request

**Rectangles** Boxed 500 Sheets - Premium - White

Item Code	Size (WxH) mm	Labels/sheet	Type
8712011	209 x 291	1	SE
8712014†	210 x 297	1	BC
8712059	105 x 297	2	BC
8712045	210 x 74.25	4	BC
8712051	200 x 60	4	SE
8712053	105 x 99	6	BC
8712084	60 x 140	6	SE
8712085	70 x 148.5	6	BC
8712086	98 x 96	6	SE
8712087	102 x 89	6	BC
8712088	155 x 40	6	SE
8712056	105 x 70	8	BC
8712089	101 x 74	8	BC
8712090	105 x 68	8	BC
8712091	70 x 52	10	SE
8712092	85 x 55	10	SE
8712005	64 x 72	12	SE
8712093	68 x 68	12	BC
8712094	99.1 x 42	12	SE
8712012	99 x 34	16	SE
8712016	64 x 47	18	SE
8712097	96 x 30	18	SE
8712025	70 x 42.4	21	BC
8712099	70 x 38	21	BC
8712107	38.1 x 21.2	65	SE

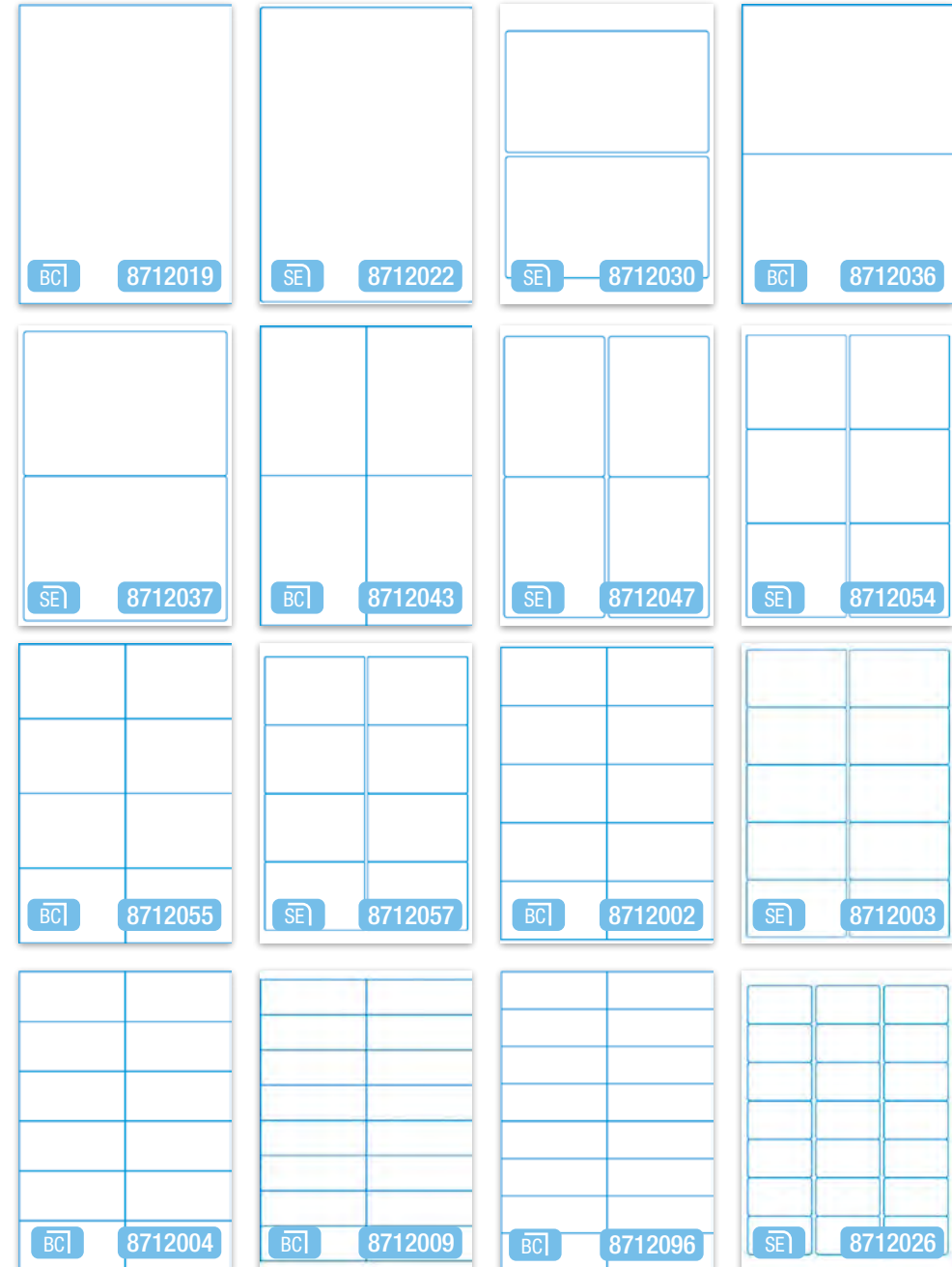

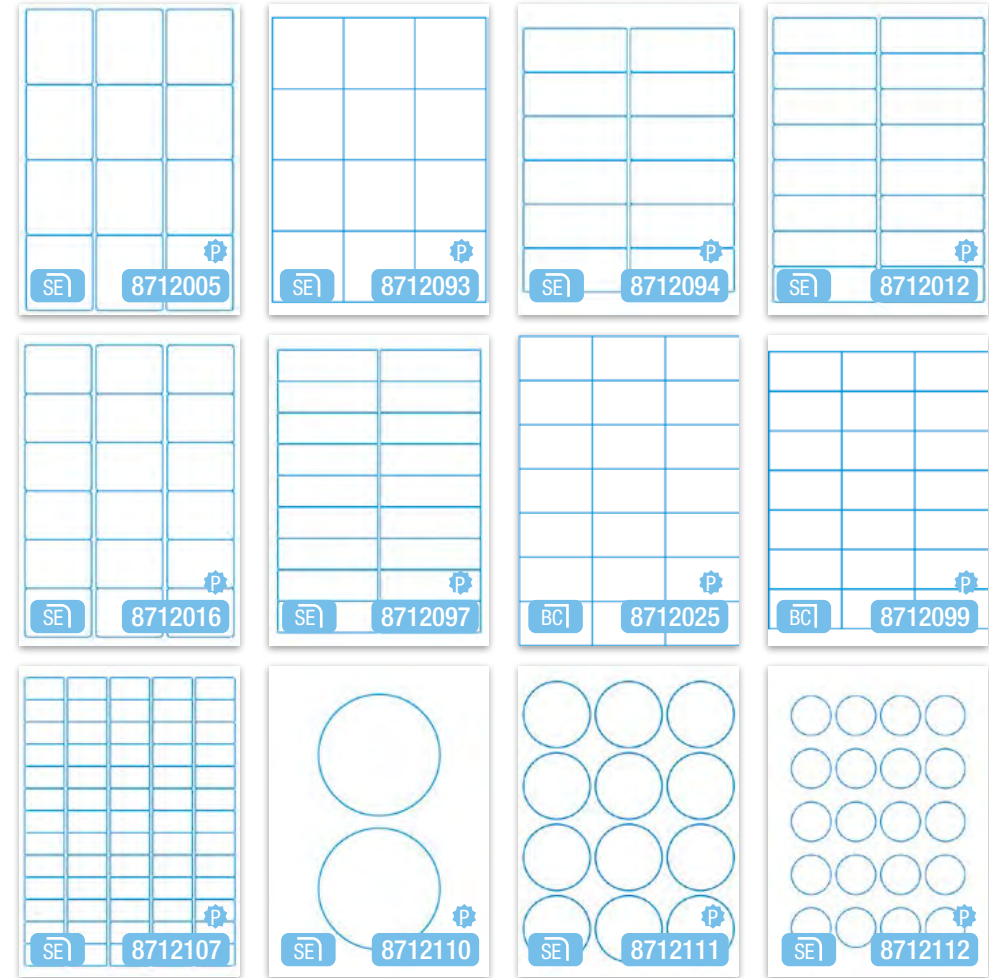
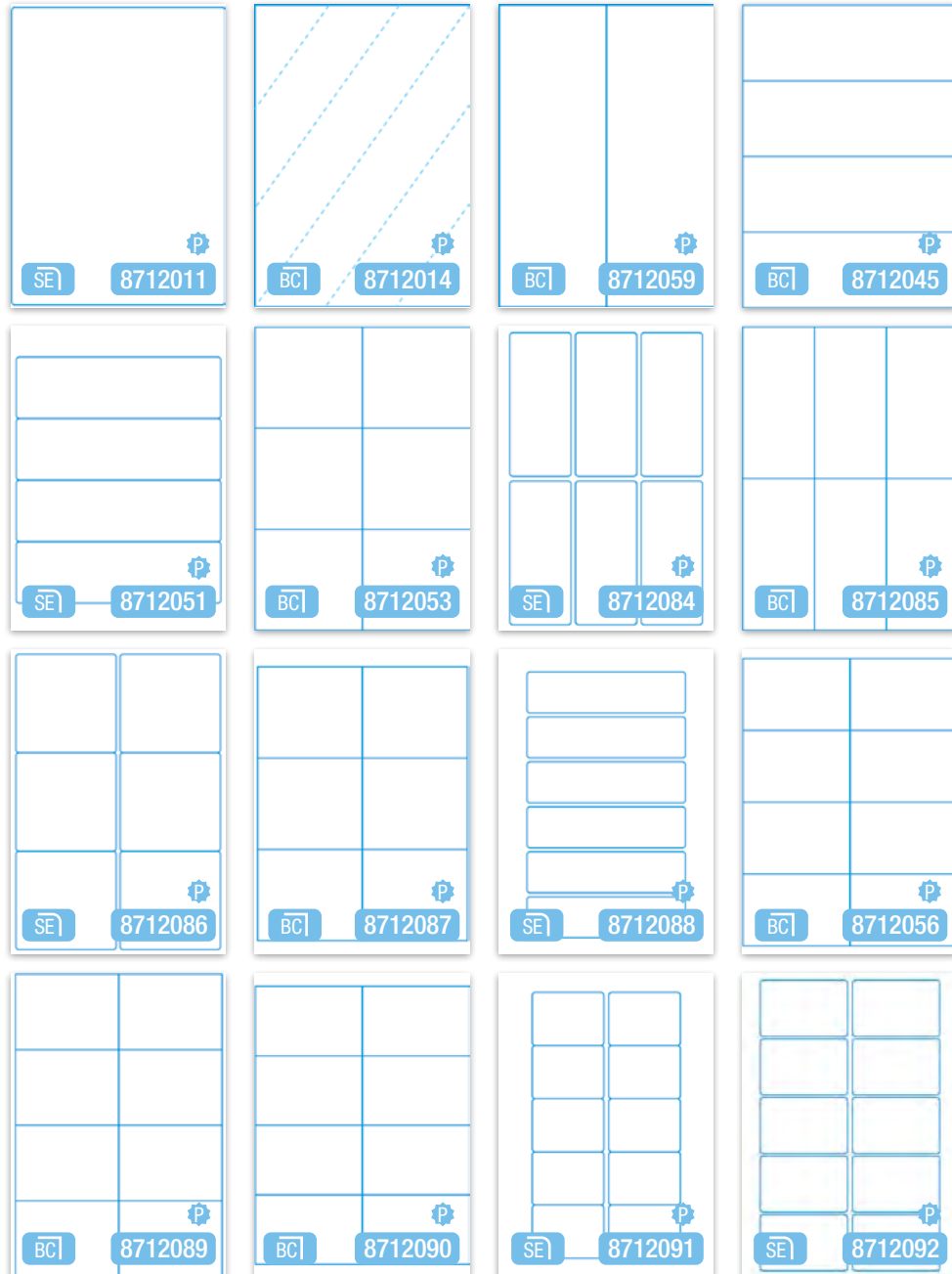

**...and many more!**

We stock lots of different label options, more than can be included here. Please contact our sales team with any specific requirements to receive a competitive no-obligation quote.

# FREE GIFTS

Choose a free gift when you place your order online



Order value	Order value
A7 Post-it Pad £50	Bonus Beanie Hat £275
Bonus Eco Pen £75	Bonus Eco Notebook and Pen £300
Desk Pad £75	Bottle of Wine £350
Dairy Milk Bar 100g £100	Bonus 6 Panel Football (size 5) £400
Toblerone 100g £100	Bonus Thermal Mug £450
Ice Scraper (recycled & recyclable) £100	Bonus Rugby Ball £600
Tin of Shortbread Biscuits £150	Bluetooth Speaker £650
Box of Chocolates or Confectionery £250	£10 High Street Voucher £800
Bonus Wilton China Tea Mug £250	Bluetooth Earbuds £850
Sports Bottle £275	Soft Shell Jacket (Black) £950
	Soft Shell Jacket (Navy) £950

Order values as of printing. Order value excludes VAT. Gifts are subject to availability.

# MEASUREMENTS AND TERMS EXPLAINED

**Acronyms & Terms** The meanings for some commonly used acronyms and terms.

TERM	MEANING
"	Inches - eg. 10" means a measurement of 10 inches
'	Feet - eg. 10' means a measurement of 10 feet
mu	Micron - Often refers to a material thickness such as plastic film
G	Gauge - Often refers to a material thickness such as plastic film
GSM	Grams per Square Metre - A measurement of paper and card weight/thickness
PPS	Power Pre-Stretch - Pallet wrap film can be PPS, as can a pallet wrapping machine with PPS capability

## Comparison Charts

KG	LB
5	11
10	22

PALLET SIZE	MM
Standard Pallet	1200 x 1000
Euro/Europa Pallet	1200 x 800

MM	INCHES
50	1.97
100	3.94
200	7.87
300	11.81
400	15.75
500	19.69
1000	39.37
1500	59.05
2000	78.75

MICRON	GAUGE
5	20
6	24
9	35
15	60
17	67
25	100
40	160
50	200
100	400

PAPER SIZE	MM
A8	52 x 74
A7	74 x 105
A6	105 x 148
A5	148 x 210
A4	210 x 297
A3	297 x 420
A2	420 x 594
A1	594 x 841
A0	841 x 1188

ENVELOPE	MM
C7	84 x 114
C6	114 x 162
C5	162 x 229
C4	324 x 229
C3	458 x 324
DL	110 x 220

**Need help choosing the best packaging solutions for your goods?**

Contact us to discuss your options. We can send free samples and carry out on-site or online product demos.

## BONUS PACKAGING ASSESSMENT



See detailed insights in to your packaging a processes. Discover where time and costs can be saved. **Contact us to arrange a visit.**





Ask us for a free demo

Next day delivery

**ORDER NOW!**

Machines in stock

SCAN HERE



## Optimus<sup>®</sup> Wrappers

Wrap loads faster and more efficiently.

See page 74.

Contact us for more details.

## Optimus<sup>®</sup> Wrap

High performance pallet wrap.

Range includes 30% recycled films.

See page 50.



### Bonus Trading

☎ 08000 540 100

✉ sales@bonustrading.co.uk

[bonustrading.co.uk](http://bonustrading.co.uk)

**BRCS**

Storage and Distribution

CERTIFICATED



Trading House, Harvard Industrial Estate, Kimbolton PE28 0NJ  
Carlton House, 34-36 Carlton Park Industrial Estate, Saxmundham IP17 2NL

Bonus Trading UK Limited. Registered in England No. 8151258. VAT Registration No. GB 847 1197 10



**Stay up to date and informed about packaging solutions**

Receive occasional emails with offers and updates about new and innovative products.

Join our mailing list at [bonustrading.co.uk](http://bonustrading.co.uk)