



Innovation in Packaging & Labels



	<b>Pallet Wrap</b>	<b>12</b>
	<b>Tapes</b>	<b>26</b>
	<b>Postal Products</b>	<b>36</b>
	<b>Boxes &amp; Cartons</b>	<b>44</b>
	<b>Protective Products</b>	<b>50</b>
	<b>Packaging</b>	<b>72</b>
	<b>Strapping</b>	<b>76</b>
	<b>Services</b>	<b>84</b>
	<b>Gifts</b>	<b>86</b>

Order by 3pm

Next day delivery on all stock items

Join our mailing list

Receive emails with new products, bulk deals and offers.

Join now at [bonustrading.co.uk](http://bonustrading.co.uk)

Order online **SCAN HERE**





Welcome to **Go Green 2**, full of eco-focused packaging, all ready for immediate despatch across the UK and Europe.

We have included many new products, some are environmentally friendly alternatives to plastic, while others are more 'eco' versions of standard virgin plastic products. All these options can help towards reducing plastic waste and your carbon footprint.

Bonus Trading offers great value and an unbeatable service, backed up by an extensive stock range of products. With over 18 years experience, you can count on us for all your packaging and labelling solutions.

### *The Bonus Team*

**We are recognised for our commitment to providing high quality products and services**



**BRCGS  
ACCREDITATION  
AA CERTIFIED**

Storage and Distribution  
**CERTIFICATED**

Bonus Trading has been awarded the highest grade BRCGS certification in the Storage and Distribution sector. We are listed in the BRCGS Global Standards Directory which can be searched online.

**Mission Statement**

“ Our mission is to supply great value services and products, while supporting all of our customers in achieving their targets, and to provide consistent and sustained quality through our professional packaging and labelling solutions. ”



# Need help choosing the best sustainable packaging solutions for your goods?

We have a vast knowledge of the available packaging options to protect your products. We can help explain the pros and cons of new packaging solutions and sustainable materials.

If there is anything in this catalogue that you want to understand better - just call us, we are always happy to talk packaging.

We will provide unbiased advice about the performance of alternative solutions and how well they will suit your exact needs.

We can send samples and carry out on-site or online demonstrations and comparisons.

Contact us for expert advice and to discover the perfect packaging for you and your goods.

**Call us on  
08000 540 100**

Eco Materials Guide	6
Our Top Pick Eco Products	8
Protecting Loads - Diagrams	10
Pallet Wrap	12
Wrapping Machines & Finance	12
Machine Film	16
Grip Film	18
Hand Film	22
Tapes	26
Postal Products	36
Cartons & Boxes	44
Protective Products	50
Bubble Wrap	50
Edge Protection	54
Void Fill	62
Bottle Protection	70
Packaging	72
Top Sheets	74
Strapping	76
Our Services	84
Gifts	86
Size Comparison Charts	87

# HOW WE GO GREENER

Bonus Trading has made more changes to reduce the environmental impact and carbon footprint of doing business

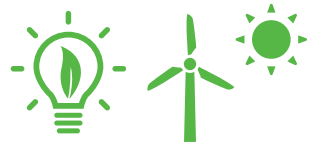

## Energy Usage

Our warehouses now use motion sensor activated LED lighting, so we aren't using energy unnecessarily. Our electricity policy is Zero Carbon and all of our electricity is provided via green, zero-emission energy supplies.



## Reduced Carbon Footprint

We buy stock as close to home as possible to limit CO<sub>2</sub> emissions related to procurement. We have invested in our delivery lorries which are the latest UK standards and we optimise route planning to minimise the number of miles travelled.



## Logistic Improvements

We've made logistical improvements and changes to the products and equipment we use. We source the best high yield supplies to minimise our carbon footprint.



## Materials and Recycling

We use more products made from sustainable materials and where possible we recycle the waste generated during the daily operations of our warehouses and offices.



## Sustainable Forestry

Bonus Trading is a certified FSC® supplier and we uphold the integrity of the FSC® certified product supply chain. We can supply certified products upon request. Our catalogues are printed on FSC® certified paper and also sent without plastic film wrap.

The mark of responsible forestry



Through the **One Tree Planted** organisation, we make donations that help support reforestation projects to plant more trees.

**Our promise is 1 tree for every 23 orders**

Our trees will absorb carbon from the atmosphere for years to come, helping to offset the carbon generated from the activities of our business.



Do you want to start planting trees? Ask us about this or visit [onetreepanted.org](https://onetreepanted.org)

# ECO PACKAGING MATERIALS

How using alternative packaging materials can be better for the environment

## Paper & Cardboard

Paper and card products are generally better than plastic and usually the best environmentally conscious choice for any packaging solutions.

Made from wood pulp, most will break down in nature, many are compostable and/or recyclable.

We can source FSC certified paper and card products upon request.



See compostable paper "Documents Enclosed" wallets on page 43

## Metal

Metal is often a better choice compared to plastic, as the material doesn't usually have a negative impact on the environment.

In most cases, metal products will not cause harm to the natural world after their use. They will oxidize, rust and corrode over years, breaking down and returning to nature. Most metals can also be easily recycled.



See our metal strapping range on page 78

## Plastics

It is well known that plastics are not good for the environment, they are made using fossil fuels and most plastic materials can remain in the environment for many years.

Using recycled plastics is often better, but switching to higher yield products or non-plastic alternative products can be the best way to reduce your plastic use, and also save on Plastic Packaging Tax costs.



See Blue Ocean air pillow void fill on page 68  
Made with 100% recycled plastic

## Bonus Packaging Assessments

To discover more about your packaging use and where improvements can be made, ask us about a packaging assessment and analysis.

## Need more information?

Please contact us if you need more info and details about any specific products, manufacturing processes or any materials data.

Details of the **Plastic Packaging Tax (PPT)** can be found on the [gov.uk](https://www.gov.uk) website

# ECO MATERIAL BADGES

How we indicate the types of materials used in our packaging products



Made from materials that can be composted, this will usually be paper and cardboard. These are made from wood pulp and will break down in nature. Many are constructed with starch based adhesives. Some products, such as envelopes, may have adhesive strips that should be removed before composting.



Made from materials that can be recycled. This could be paper or cardboard, or a recyclable plastic/polymer. Many sturdy and reasonably thick plastic and cardboard materials can be recycled 'kerb-side' via home or business recycle bin collection. Thinner paper materials and plastic films may require being sent to specialist recycling service providers.



Made from materials that might biodegrade - however, some materials are still undergoing lengthy research. These may degrade in nature over time, this could take some weeks, months or years. Oxo-degradable plastics (plastics that are designed to degrade by oxidation) can leave microplastics in the environment.

Card and paper are also technically biodegradable, but for the purpose of our labelling, we are using the more descriptive 'compostable' badge to indicate those products.



Made using recycled materials, either completely or as a percentage of content. The percentage stated within the badge is the approximate amount of recycled content used in manufacture, with the remainder being virgin material. In the case of 30% recycled, this is the minimum percentage, meaning the material will not be subject to plastic packaging tax.



Recycled plastics/polymers may have been sourced from pre-consumer (post-industrial) or post-consumer waste, or a mix of both. Some recycled plastics may not be suitable for use in food packaging, please contact us for more details about individual products.

## OUR TOP PICKS...



A few recommended products from our eco-aware and sustainable packaging solutions.

More online



### 100% PAPER 'DOCUMENT ENCLOSED' WALLETS



Traditionally made of plastic film, these 100% paper wallets are recyclable and compostable. A simple change that makes box recycling easier.



See page 43

### 100% RECYCLED FOAM EDGE PROTECTION



Foam edge protection made from 100% recycled plastic content. Exempt from Plastic Packaging Tax.



See page 54

### CORRUGATED CARDBOARD BOTTLE SLEEVES



100% paper/card construction, the innovative design creates an elasticated effect when stretched over the item.



See page 70

### OPTIMUS® PALLET WRAP



High yield, high performance pallet wrap film. Less plastic, less waste, lower carbon footprint and lower costs. 30% recycled plastic options.

See page 16

Optimus®



### GRIP FILM® ECO PALLET WRAP



High yield hand pallet wrap, 30% recycled film. Uses less plastic, creates less waste, lower carbon footprint.

See page 18



### ECOMMERCE CARDBOARD BOXES



Easy-fold cardboard boxes, requiring less tape. Sized for small parcel and large letter, ideal for ecommerce sales.

See page 46



### RI-FILL PAPER PADDING & VOID FILL



Pad and protect products with 100% paper based shaped padding, void fill and protection.

See page 64



# PROTECTING LOADS

We stock everything you need to prepare your pallet loads and keep them safe during transit & storage.

■ Page 44  
**Boxes & Cartons**

We stock a vast selection of boxes, single and double wall.

■ Page 74  
**Top Sheets**

Protect the tops of your pallet loads.

■ Page 58  
**Layer Pads & Anti-Slip Sheets**

Stabilise layered loads and prevent movement.

■ Page 26  
**Tapes**

Our huge selection includes paper and poly tapes, specialist tapes and security seals.

■ **Labels & Seals**

Apply labels with your branding and information. We stock many different labels, ribbons and printers.

See [bonustrading.co.uk](http://bonustrading.co.uk) or our *InStock* catalogue

■ Page 50  
**Protective Packaging & Void Fill**

Ensure your items are protected inside their boxes. We stock a variety of different protective solutions.

■ Page 58  
**Pallets**

We can supply new or used pallets. We also stock pallet boxes.

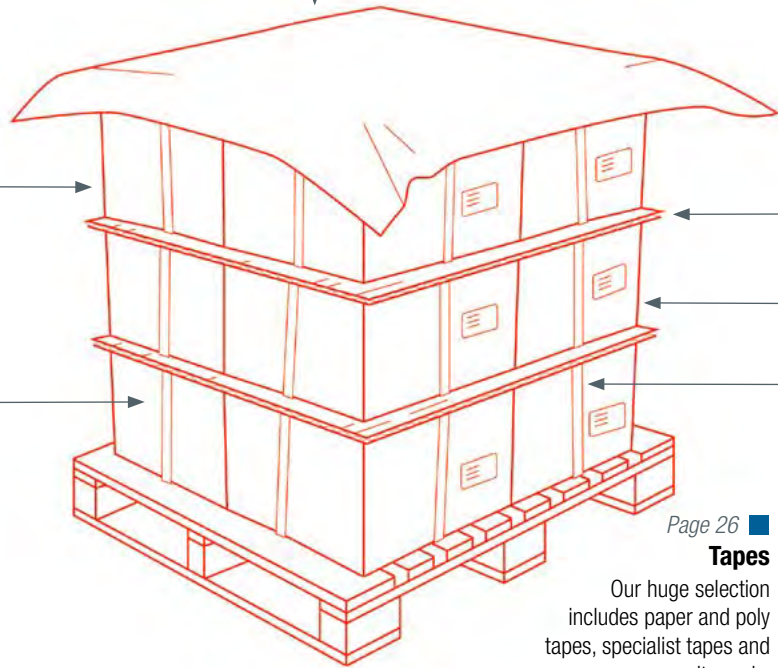

Need help choosing the most suitable packaging for your items and loads? Our team can provide advice and recommend options.

Find out which solutions can be more efficient, save costs and time. Ask us about packaging assessments and pallet wrap audits.

■ **Warning Labels**

Clear warning labels for hazardous loads. See [bonustrading.co.uk](http://bonustrading.co.uk) or our *InStock* catalogue

■ Page 58  
**Pallet Cones**

Prevent damage from stacking loads of fragile items.

■ Page 54  
**Edge Protection**

Protect edges from light impacts and wrap & strap tension.

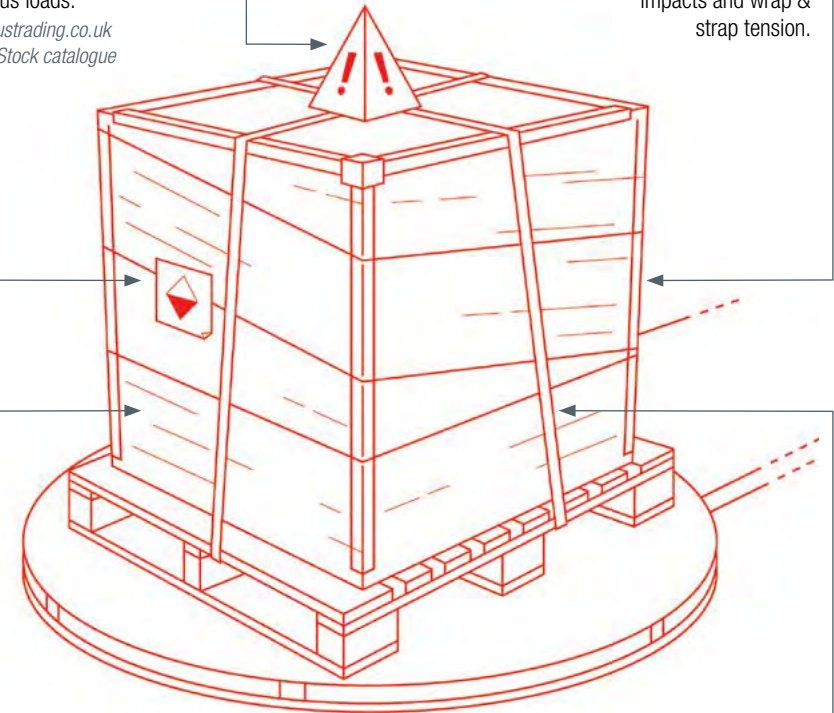

■ Page 16  
**Pallet Wrap Stretch Film**

We stock many film types, including high yield to reduce plastic waste.

■ Page 12  
**Pallet Wrapping Machines**

Quickly and efficiently wrap pallets with ease. Our payment plans can help you spread the cost of a new machine.

■ Page 76  
**Strapping**

Secure loads and prevent movement. 100% paper strapping now available.

**Pallet Wrapper Machines** Standard & Electromagnetic

- 1650mm diameter turntable
- Adjustable turntable speed - 5-15 rpm
- Wrapping height: 2.2m
- Capacity: 2000kg
- Carriage type: Mechanical or electromagnetic brake
- Film stretch: Manual adjustable (Std), Electronic (other models)
- Adjustable film carriage speed to achieve the optimum cost effective and secure wrap
- 6 recordable program settings on most models
- Progressive start up, to ensure safe wrapping of unstable loads
- Photozell delay
- Height detection photocell
- Programmable wrap cycles
- Manual cycle
- Easy to view and operate control panel
- OLED display and membrane keypad
- Emergency stop button
- Front and rear forklift entry
- Power: 230v ~
- Ideal to replace hand wrapping of up to 20 pallets (150M) or 30 pallets (150E) per day

**PAYMENT PLANS AVAILABLE** See page 15

See machines online



**Optimus**  
Wrapper



**FROM £125 PER MONTH\***

**1-30** Recommended to replace hand wrapping 1-30 pallets per day

Ask us for a demo

Model shown: 150E

- Ramps for easy loading



**6616199**

Item Code	Description
<b>6616256</b>	150ME Wrapper - Entry Level
<b>6616171</b>	150M Wrapper - Standard
<b>6616172</b>	150E Wrapper - Electromagnetic Brake

Item Code	Description
<b>6616199</b>	Loading Ramp (1650mm / 1 tonne)
<b>6616200</b>	Loading Ramp (1650mm / 2 tonne)
<b>6616201</b>	Extended Ramp (1650mm / 1 tonne)

\* Costs correct at printing

Start wrapping pallets fast and efficiently now. Ask us about machine finance plans.

**Pallet Wrapper Machines** Power Pre-Stretch

- 1650mm diameter turntable
- Adjustable turntable speed - 5-15 rpm
- Wrapping height: 2.2m
- Capacity: 2000kg
- Carriage type: Power Pre-Stretch Motorised / Pre-stretch 250%
- Film stretch: Potentiometer
- Adjustable film carriage speed to achieve the optimum cost effective and secure wrap
- 6 recordable program settings
- Progressive start up, to ensure safe wrapping of unstable loads
- Photozell delay
- Height detection photocell
- Programmable wrap cycles
- Manual cycle
- Easy to view and operate control panel
- OLED display and membrane keypad
- Emergency stop button
- Front and rear forklift entry
- Power: 230v ~
- Ideal to replace hand wrapping of 30+ pallets per day

**PAYMENT PLANS AVAILABLE** See page 15

**FROM £196 PER MONTH\***

**30+** Recommended to replace hand wrapping 30+ pallets per day

Ask us for a demo



**Optimus**  
Wrapper



Item Code	Description
<b>6616173</b>	250E Wrapper - Power Pre-Stretch

- We can also supply photocells for dark products and grounding frames for installing turntables directly in to the floor slab.

Wrapper base options include low profile and slotted for trolley loading. Ask our team for details.

Ask us about more options for wrapper machines, including ramps, gear sets and weighing kits

\* Costs correct at printing

**Robot Pallet Wrapper Machines**

- Self propelled wrapping machine
- Automatically moves around the pallet or any sized load
- Stabilises light, irregular and fragile loads easily
- Can wrap pallets in less than a minute
- Choice of carriage types
- Film stretch: Manual adjustable (Std), Electronic (other models)
- Control panel with display, 250ER+ has touch screen
- Smooth, easy movement thanks to movement rudder
- Safety bumpers
- Emergency immediate stop button
- Wrapping height: 2.2m
- Power: 230v ~
- Models available include standard, entry level and PPS



**FROM  
£177  
PER MONTH\***



Item Code	Description
6616184	150MRE Robot Wrapper - Entry Level
6616261	150MR Robot Wrapper - Standard
6616262	150ER Robot Wrapper - Electromagnetic
6616263	250ER Robot Wrapper - Power Pre-Stretch
6616266	250ER+ Robot Wrapper - PPS (x2 Motors)

**Rotary arm pallet wrapping machines** are also available. Ask us for more details or see online at [bonustrading.co.uk](http://bonustrading.co.uk)

Is your pallet wrapper having performance issues? We can replace or service your machines. See page 85

**Optimus® Wrap**



- High performance film
- Helps to reduce costs
- Reduces plastic waste
- Wraps more per roll



**New!**

Choose from our range of strong, high yield and eco 30% recycled films

See page 16



**WRAPPER MACHINE FINANCE PAYMENT PLANS**

**You can have a new wrapper machine installed sooner than you think**

Ask our team about machine finance plans - you'll soon be wrapping your loads faster, better and more efficiently.

We can also provide a servicing package - we'll visit you periodically to ensure your machine is always running at optimal performance!



**TALK TO US ABOUT FINANCE OPTIONS**

You could take delivery of a new machine now!

**Example payment plans**

Includes machine, ramp and full installation on your premises.



6616173  
**250E PPS Model**  
£196 per month\*  
x36 repayments



6616256  
**150ME Entry Level Model**  
£125 per month\*  
x36 repayments



6616184  
**150MRE Robot Entry Model**  
£177 per month\*  
x36 repayments

\* Plans and costs correct at printing . Offers are subject to change.

### Optimus® X Machine Stretch Film Pallet Wrap

- High quality range of stretch film pallet wrap
- Optimus brand high performance film
- For use with wrapping machines
- Film is recyclable via specialist processors
- 250-300% elongation
- Strong, high yield film
- 16kg rolls

### Optimus® X Wrap

Optimus films can help reduce costs by reducing your plastic usage, even when factoring in Plastic Packaging Tax. Contact us about your film usage and we can provide analysis, costs or arrange an audit.



**New!**  
Optimus brand machine film

Switching to Optimus high yield films can reduce plastic waste and costs

20+ pallets per roll

Item Code	Description	Core	Colour	Type	Width	Unit
1816041	Optimus X2S	Std	Clear	Standard Stretch	500mm	Each
1816040	Optimus X5S	Std	Clear	Standard Stretch	500mm	Each
1816030	Optimus X2	Std	Clear	Power Pre-Stretch	500mm	Each
1816031	Optimus X5	Std	Clear	Power Pre-Stretch	500mm	Each

\* Average saving is 50%. Savings can range from 40-60%.

#### Ask us for a free wrap film audit - *No obligation*

- Comparison tests with your current wrap film and Optimus films
- Detailed reports, recommendations and clearly explained results
- Film yield, pallets per roll and performance analysis
- Projected cost savings, plastic waste reduction and carbon footprint
- Efficiency and time saving, fewer roll changes and machine downtime



### Optimus® Eco 30% Recycled Machine Stretch Film Pallet Wrap

- High quality range of stretch film pallet wrap
- Optimus brand 30% recycled content film
- For use with wrapping machines
- Film is recyclable via specialist processors
- 200-250% elongation
- Strong, high yield film
- Exempt from Plastic Packaging Tax
- 16kg rolls

### Optimus® Eco Wrap

Optimus Eco Wrap is the perfect high performance recycled-content pallet wrapping film.



**New!**  
Optimus brand 30% recycled film  
Exempt from Plastic Packaging Tax

Ask us about a packaging assessment. We can help you reduce costs and plastic waste

Item Code	Description	Core	Colour	Type	Width	Unit
1816033	Optimus Eco X7S	Std	Clear	Standard Stretch	500mm	Each
1816034	Optimus Eco XXS	Std	Clear	Standard Stretch	500mm	Each
1816035	Optimus Eco XX3S	Std	Clear	Standard Stretch	500mm	Each
1816036	Optimus Eco X7	Std	Clear	Power Pre-Stretch	500mm	Each
1816037	Optimus Eco XX	Std	Clear	Power Pre-Stretch	500mm	Each
1816038	Optimus Eco XX3	Std	Clear	Power Pre-Stretch	500mm	Each

No need to change machine settings when switching to Optimus film. Just load the roll and start wrapping.

Reduce your plastic waste by 50%, save film and lower your operation costs with Optimus wraps





grip SYSTEMS

## Grip Twist-Lock Dispenser

- A more efficient way to wrap pallets
- Fast and secure locking system
- Magnetic, convenient off-floor storage

Item Code 6616159



Super fast roll change system



Secure non-slip core retention



Set the perfect tension



Extra tough skid plate



Comfortable ergonomic grip

Save up to  
**40%**  
with Grip Film

- High yield Pre-stretched film
- Use less plastic
- Save on storage space

For Grip Film rolls see page 20

30% recycled content film now available

**FREE DEMOS & TRAINING**  
Contact us to book now!

## Grip® Twist-Lock Magnetic Dispenser

- Fast and secure locking system
- Lightweight, with ergonomic grip handle
- Magnetic, to keep handy in the warehouse
- Use with rolls of Grip Film pallet wrap



Free on-site demos & training

See Grip Film rolls on the next page



Item Code	Description	Unit
6616159	Grip Twist-Lock Magnetic Dispenser	Each



grip SYSTEMS

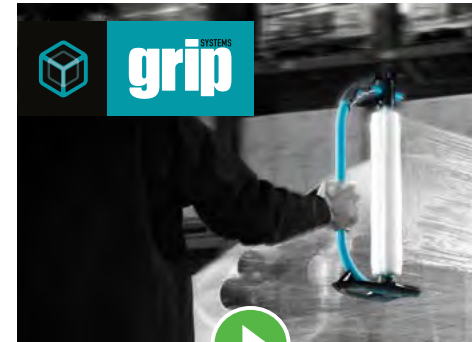

## See Grip® Film in action

Watch the video at [bonustrading.co.uk](http://bonustrading.co.uk) or book a live demo with us. We can arrange to visit you or carry out the demo via online video link.

## Grip® Superior Safety Knife R/hand

- Auto retractable blade
- Die cast metal body



Item Code	Description	Unit
7516064	Grip Safety Knife - Right Handed	Each

### Grip® Film

- Pre-stretched, strong gripping, high yield film
- Pallet wrap rolls for use with the Grip Film dispenser
- Film is recyclable via specialist processors
- Easily recycle roll cores with a core bin
- 45 boxes per pallet (360 rolls)
- 8 rolls per box



See online



Reduce plastic usage with Grip Film

Grip Film is a high yield and strong gripping pre-stretched film. Secure loads with less wrap.

- Available in clear, black and colour options  
Colours require min. order of a pallet, 360 rolls

Dispenser not included



Item Code	Type	Size	Colour	Unit/Box
1616005	Superior	400mm x 480m	● Black	8 rolls
1616006	Superior	400mm x 480m	● Blue	8 rolls
1616013	Superior	400mm x 480m	● Green	8 rolls
1616014	Superior	400mm x 480m	● Red	8 rolls
1616015	Superior	400mm x 480m	● Yellow	8 rolls
1616016	Superior	400mm x 480m	● Pink	8 rolls
1616017	Superior	400mm x 480m	● Orange	8 rolls
1616018	Superior	400mm x 480m	● Purple	8 rolls
1616004	Premium	400mm x 420m	○ Clear	8 rolls
1616011	Elite	400mm x 550m	○ Clear	8 rolls
1616029	Robust	400mm x 280m	○ White Opaque	8 rolls

### Grip® Film 30% Recycled

- All the same high yield, strong gripping benefits of regular Grip Film
- Clear film, 30% recycled content
- Recyclable via specialist processors
- 45 boxes per pallet (360 rolls)
- 8 rolls per box



New!

30% recycled film

Save on plastic waste and costs

Exempt from Plastic Packaging Tax

Item Code	Type	Size	Colour	Unit/Box
1616026	Premium Eco - 30% Recycled	400mm x 420m	○ Clear	8 rolls
1616028	Superior Eco - 30% Recycled	400mm x 480m	○ Clear	8 rolls
1616027	Elite Eco - 30% Recycled	400mm x 550m	○ Clear	8 rolls
1616030	Robust Eco - 30% Recycled	400mm x 550m	● Black Opaque	8 rolls

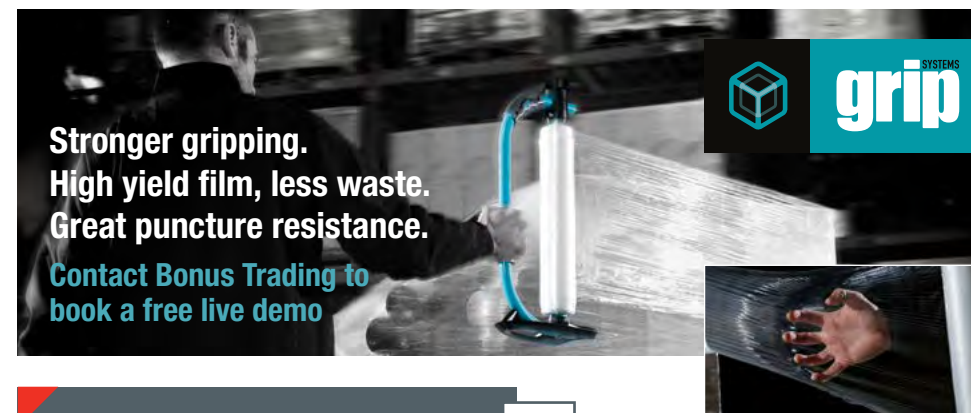

Stronger gripping.  
High yield film, less waste.  
Great puncture resistance.

Contact Bonus Trading to book a free live demo



Experience the benefits of Grip Film. Ask us about an on-site or online wrapping demonstration.



Recycle roll cores with a core bin. Contact us for more details.



**30% Recycled Hand Film Pallet Wrap**

- High quality range of hand film pallet wrap
- For manual applications
- 30% recycled content
- Film is recyclable via specialist processors



30% recycled content.  
Exempt from Plastic Packaging Tax

Item Code	Description	Micron	Core	Colour	Type	Width	Length	Unit
1716078	30% Recycled Film	15mu	Std	Clear	Cast	400mm	300m	6 rolls
1716079	30% Recycled Film	15mu	Ext	Clear	Cast	400mm	300m	6 rolls
1716080	30% Recycled Film	15mu	Std	Black	Cast	500mm	250m	6 rolls

**Heavy Duty Telescopic Pallet Wrap Dispenser**

- For pallet wrap / stretch film
- Takes core sizes: 38mm, 50mm, 75mm



We can carry out on-site or online demos of pallet wraps and many other packaging products



Find more wrap dispenser and film options at [bonustrading.co.uk](http://bonustrading.co.uk)

Item Code	Description
1216007	H/D Telescopic Pallet Wrap Dispenser

**Optimus<sup>®</sup>**

**New!**

Save **50%\*** with Optimus<sup>®</sup> films



Ask us about free demos and samples!

- High performance wrap
- High yield film
- Reduce costs
- Reduce plastic waste
- Wrap more pallets per roll
- Less machine downtime



See films on page 16



Regular pallet wrap film



**Optimus**

See online



Read more about Optimus pallet wrap film and order on our website

**Book a Pallet Wrap Audit**

With a free, no-obligation pallet wrap film audit, we will carry out comparison tests and provide a full report about your usage and costs. We often show that...

- Thicker film doesn't always mean stronger
- More wrap layers isn't always better
- Cheaper roll prices may not be lower cost

Contact us to arrange a film audit

\* Average saving is 50%. Savings can range from 40-60%.

# BONUS PACKAGING ASSESSMENT

See detailed insights in to your packaging a processes. Discover where time and costs can be saved. Find new benefits of reducing plastic usage.

Contact us to arrange a visit



## Usage insights can show that small changes will lead to big savings

Our assessments will help you to understand where simple changes and alternative products can result in big differences.

## New packaging solutions can bring a variety of improvements

Our new, innovative packaging solutions can quickly result in savings and improvements to productivity.

## Reduce your packaging usage

The assessment will show where you can improve efficiency, save time and costs, and improve product protection. All while reducing your materials waste and plastic usage.



See our new top sheet dispenser on page 74

## Pallet Wrap Audit

With a free, no-obligation pallet wrap film audit, we will carry out comparison tests and provide a full report about your usage and costs. We often show that...

- Thicker film doesn't always mean stronger
- More wrap layers isn't always better
- Cheaper roll prices may not be lower cost

Book a free wrap audit with us



Regular pallet wrap film

Optimus® film



Save 50%\* with Optimus® films

See page 16

\* Average is 50%. Savings can range from 40-60%.



## Strong, high yield stretch films

Ask us to assess your hand wrap usage; you will see how costs and waste can be reduced with the most suitable high yield films.

See page 18



PAYMENT PLAN DEALS



## Need a new wrapper machine?

You could have an efficient new pallet wrapping machine delivered now, with our fantastic finance offers.

See page 15

# CUSTOM PRINTED PAPER TAPE



ECO FRIENDLY & PRINTED WITH YOUR MESSAGE OR BRANDING

Printed tape with your logo and branding will help your shipments stay visible during transit and keep your brand memorable with your customers.

Custom printing has more uses beyond branding; you can promote goods and services, label product types, add caution messages or show instructions.

We can print on almost any tape including eco friendly paper tapes, reinforced and kraft tapes. We'll also print your other packaging to match. Tell us what you need and we'll print it.

**YOUR MESSAGE  
YOUR BRAND  
YOUR TAPE**



## Self Adhesive Kraft Tape

Standard Core 76mm

- Recyclable kraft paper tape
- 76mm core



Item Code	Width	Length	Type	Unit	Min. Order
0116152	25mm	50m	Solvent	Per roll	72 rolls
0116153	38mm	50m	Solvent	Per roll	48 rolls
0116154	50mm	50m	Solvent	Per roll	36 rolls
0116201	75mm	50m	Solvent	Per roll	24 rolls

## Reinforced S/Adhesive Kraft Tape

Standard Core 76mm

- Non-plastic filaments
- High tack hotmelt
- Recyclable tape
- 50mm width
- 25 metre roll length
- 76mm core



Item Code	Width	Length	Type	Unit	Min. Order
0116420	50mm	25m	Hotmelt	Per roll	36 rolls

## Self Adhesive Kraft Tape Small Core

- Recyclable kraft paper tape
- 0116411 designed for case tapers
- 0116443 and 0116422 fit e-tape dispensers
- 0616027 use with ZeroTape dispensers



See dispensers pages 28-29



### 50mm core - e-tape® paper tape

Item Code	Width	Length	Type	Unit	Min. Order
0116452	50mm	100m	Solvent	Per roll	36 rolls
0116422	72mm	100m	Hotmelt	Per roll	24 rolls



### Small core - ZeroTape® paper tape

Item Code	Width	Length	Type	Unit	Min. Order
0616027	48mm	70m	Hotmelt	Per roll	36 rolls

### Standard Pistol Grip Dispenser

- Pistol Grip dispenser for standard tape
- 75mm core



Item Code	Description	Size
1116050	Standard Dispenser	50mm
1116038	Standard Dispenser	75mm

### Heavy Duty Pistol Grip Dispenser

- Premium heavy duty Pistol Grip with metal frame
- Safety blade cap
- Static suction adjustable grip
- 75mm core



Item Code	Description	Size
1116044	Heavy Duty Dispenser	50mm
1116036	Heavy Duty Dispenser	75mm

### e-tape® Silent Dispenser

- Retractable safety blade
- For use with 50mm core tape rolls
- The ultimate tape dispenser



**BEST SELLER**

Item Code	Description	Size
1116022	e-tape Dispenser	50mm
1116063	e-tape Dispenser	75mm



Use with 50mm core tape rolls. See page 27

### Pistol Grip Replacement Blades

- Pistol Grip dispenser blades



Ask us about other dispensers & accessories

Item Code	Description	Blades Per Pack/Unit
1116070	50mm Standard	10
1116081	75mm Standard	10
1116083	50mm Heavy Duty	15
1116082	75mm Heavy Duty	10

### ZeroTape® Dispensers

- Ergonomic designs for ease of use
- 50mm size, use with 48mm ZeroTape rolls



**ZEROTAPE**

See tape on page 27

1116078

1116071

Item Code	Description	Unit
1116078	50mm ZeroTape Classic Disp. Blue	Each
1116071	50mm ZeroTape First Disp. Blue	Each
0616006	50mm Replacement Blade	Each
0616005	50mm Replacement Wiper	Each

### e-tape® Replacement Blades & Wipers



Item Code	Description	Size	Unit
0216004	e-tape Dispenser Blade	50mm	Each
0216121	e-tape Dispenser Blade	75mm	Each
0216002	e-tape Dispenser Wiper	50mm	Each
0216122	e-tape Dispenser Wiper	75mm	Each



If you need to use polyprop tape, choose e-tape®  
Fewer roll changes. Lower carbon footprint.  
To see all of our tape ranges, please visit [bonustrading.co.uk](http://bonustrading.co.uk)

**Water Activated Tape (WAT) Gummed Paper Tape**

- Gummed inside (GSI) or gummed outside (GSO)
- Water activated, starch adhesive - safe for the environment
- Recyclable, compostable and biodegradable



Item Code	Width	Length	Type	Colour	Unit	Min. Order
0116129	48mm	200m	GSI	Kraft	Per roll	30 rolls
0116142	48mm	200m	GSI	White	Per roll	30 rolls
0116130	48mm	200m	GSO	Kraft	Per roll	24 rolls
0116131	70mm	200m	GSI	Kraft	Per roll	18 rolls
0116132	70mm	200m	GSO	Kraft	Per roll	16 rolls
0116133	96mm	200m	GSI	Kraft	Per roll	12 rolls
0116134	96mm	200m	GSO	Kraft	Per roll	12 rolls

All water activated gummed tapes without reinforcing filaments are 100% compostable and will fully decompose



Ask us about bespoke tapes and custom printing with your own message



**Reinforced WAT Gummed Paper Tape**

- Water activated, starch adhesive
- Extra strong paper tape
- Non-plastic filaments
- Recyclable



Item Code	Width	Length	Type	Unit	Min. Order
0116140	48mm	100m	GSI	Per roll	12 rolls
0116141	70mm	100m	GSI	Per roll	6 rolls
0116448	70mm	152m	GSI	Per roll	6 rolls

Recommended tape for use with WAT gummed tape dispensers. See page 34

Reinforced gummed tapes feature glass fibre filaments. While not harmful to the environment, these tapes are not compostable and should be recycled.

**Recycled PET Tapes 48mm width**

- 48mm rPET adhesive tape rolls
- Made from 85% recycled plastic consumer waste
- e-tape and ZeroTape options



Made with 85% recycled plastic



Item Code	Length	Type	Colour	Unit	Min. Order
0216128	150m	Hotmelt	Clear	Roll	36 rolls
0216129	150m	Hotmelt	Brown	Roll	36 rolls

Item Code	Length	Type	Colour	Unit	Min. Order
0616033	180m	Hotmelt	Clear	Roll	36 rolls

### Grip® Tape Reinforced WAT Gummed Paper Tape

- Water activated reinforced paper tape
- For use with the Grip Taper dispenser
- 125gsm, 38mm core
- Recyclable



Ask us for an on-site demonstration of Grip Tape and the Taper



Item Code	Width	Length	Colour	Unit
0116477	60mm	45m	Kraft	Box/16 rolls
0116491	60mm	45m	White	Box/16 rolls



Ask us about bespoke custom printed Grip Tape

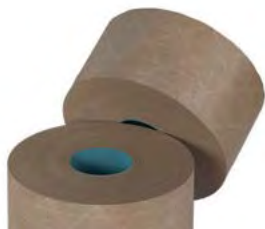

Water activated gummed paper tapes are much friendlier to the environment than plastic tapes



Use Grip Tape paper tape rolls with the Grip Taper; a versatile gummed tape dispenser that can be used at the work bench and also as a portable taper.

### Grip® Taper Paper Tape Dispenser

- Portable water activated tape dispenser
- Use with Grip Tape WAT gummed tapes
- Built in water tray
- Battery powered

New!



See online



See Grip® Taper in action  
Watch the video at [bonustrading.co.uk](http://bonustrading.co.uk) and book a live demo with us

Great for the workstation or use as a fully portable tape dispenser



Item Code	Description
6616160	Grip Taper Paper Tape Dispenser
6616161	Grip Taper Spare Battery
6616162	Grip Taper Spare Roller
2416105	Demineralised Water
7716026	Grip Taper Dispenser Stack Arm

Use the Taper with Grip Stack to create a tidy work area. See the Grip Stack on page 63

### Manual Gummed Paper Tape (WAT) Dispenser

- Suitable for plain and reinforced gummed tapes up to 76mm in width
- Durable steel side frame construction
- Dispense up to 76cm of tape in one stroke
- Simplified tape length settings
- Easy to use and simple maintenance
- Uniform wetting and clean cutting



Item Code	Description	Weight
1116053	Tape Dispenser - Manual	10kg

Need help choosing manual or electric tape dispensers? Talk to our team for assistance.

### Electric Gummed Paper Tape (WAT) Dispenser

- Suitable for plain and reinforced gummed tapes up to 76mm in width
- Rugged design, steel frame and ABS casing
- Electronic key pad for pre-determined length, dispensing up to 305cm
- Adjustable heater warms the water, optimising bonding
- UL, CSA and CE approved
- Uniform wetting and clean cutting
- Tape output at 114cm per second



Item Code	Description	Weight
1116054	Tape Dispenser - Electric	13kg



See paper tapes on pages 31-32

### Manual Gummed Paper Tape (WAT) Dispenser

- Suitable for plain and reinforced gummed paper tapes between 25mm and 76mm in width
- Easy pull handle for variable tape lengths in a single pull
- Up to 91cm of tape in one stroke
- Accommodates up to 305m length tape rolls, max roll diameter is 222mm
- Apex guillotine style cutter for precision cutting
- Hassle free operation and drop-in tape loading
- Large 2ltr water bottle, fewer refills
- Metal chassis and tape feed
- Metric measurements



Item Code	Description	Weight
1116087	Tape Dispenser - Manual	11kg



Ask us for a dispensers demo

### Electric Gummed Paper Tape (WAT) Dispenser

- Suitable for plain and reinforced gummed paper tapes between 25mm and 76mm in width
- 20 pre-set lengths, programmable repeat long and short
- Dispenses tape at 91cm per second
- Accommodates up to 305m length tape rolls, max roll diameter is 222mm
- Constant warm water for better tape adhesion
- Apex guillotine style cutter for precision cutting
- Easy operation and drop-in tape loading
- Large 2ltr water bottle, fewer refills
- Metal chassis and tape feed
- Metric measurements
- 220/240v ~
- 2.3m long power cord



Item Code	Description	Weight
1116080	Tape Dispenser - Electric	12kg

Find paper WAT tapes on page 31

**Honeycomb Padded Paper Envelopes**

- With honeycomb construction paper padding
- Fully paper/card, 100% recyclable
- Peel and seal closure fixing



Paper honeycomb padding layers protect the envelope contents

**Manilla Honeycomb Envelopes**

Item Code	Size	Ref	Colour	Unit
4216122	100 x 165mm	Light 000/A	Manilla	200
4216123	150 x 215mm	Light 00/B	Manilla	100
4216124	165 x 180mm	Light 0/C	Manilla	100
4216125	180 x 265mm	Light 1/D	Manilla	100
4216126	240 x 340mm	Light 3/F or 4/G	Manilla	100
4216127	350 x 470mm	Light 7/K or 6/J	Manilla	50



**White Honeycomb Envelopes**

Item Code	Size	Ref	Colour	Unit
4216128	100 x 165mm	Light 000/A	White	200
4216129	150 x 215mm	Light 00/B	White	100
4216130	165 x 180mm	Light 0/C	White	100
4216131	180 x 265mm	Light 1/D	White	100
4216132	240 x 340mm	Light 3/F or 4/G	White	100
4216133	350 x 470mm	Light 7/K or 6/J	White	50



**Jiffy® Padded Envelopes** Paper Fibre Lining

- Protective Jiffy Green padded mailing bags
- Tough and durable outer paper
- Eco-friendly padded lining, made from 100% recycled paper fibres
- Excellent cushioning and shock absorption
- Breathable - suitable for some organic goods such as seeds and bulbs
- Paper construction will absorb grease from mechanical parts during transit
- Peel and seal closure fixing



Item Code	Size	Size Ref	Unit
4216059	107 x 235mm	PB00	200
4216058	132 x 235mm	PB0	200
4216060	164 x 285mm	PB1	100
4216061	196 x 285mm	PB2	100
4216062	196 x 350mm	PB3	100
4216063	221 x 350mm	PB4	100
4216064	247 x 387mm	PB5	100
4216065	298 x 464mm	PB6	50
4216066	336 x 489mm	PB7	50
4216067	437 x 665mm	PB8	50



Durable padded protection.  
Breathable & eco-friendly

Excellent cushioning.  
100% paper fibre padding

### Padded Envelopes White

- Protective bubble lined mailing envelopes, white uncoated paper
- Eco-friendlier padding, made from 30% recycled plastic
- Peel and seal closure fixing



Item Code	Size	Size Ref	Unit
4216010	120 x 175mm	000/AW	200
4216007	140 x 225mm	00/BW	200
4216004	170 x 225mm	0/CW	100
4216013	200 x 275mm	1/DW	100
4216017	240 x 275mm	2/EW	100
4216020	240 x 350mm	3/FW	100
4216023	250 x 350mm	4/GW	100
4216027	290 x 370mm	5/HW	100
4216030	320 x 445mm	6/JW	50
4216034	370 x 480mm	7/KW	50
4216037	460 x 680mm	8/LW	50



### Heavy Duty Padded Envelopes White

- Extra strong, protective bubble lined mailing envelopes
- White uncoated paper
- Eco-friendlier padding, made from 30% recycled plastic
- Extra secure postal bags
- Peel and seal closure fixing



Item Code	Size	Size Ref	Unit
4216008	120 x 160mm	000/AW	200
4216005	145 x 210mm	00/BW	200
4216002	170 x 210mm	0/CW	100
4216011	200 x 260mm	1/DW	100
4216014	235 x 275mm	2/EW	100
4216018	250 x 335mm	3/FW	100
4216021	270 x 335mm	4/GW	100
4216024	290 x 360mm	5/HW	100
4216031	370 x 460mm	7/KW	50



### Padded Envelopes Gold

- Protective bubble lined mailing envelopes
- Golden brown uncoated paper
- Eco-friendlier padding, made from 30% recycled plastic
- Peel and seal closure fixing



Item Code	Size	Size Ref	Unit
4216147	120 x 175mm	000/AG	200
4216146	140 x 225mm	00/BG	200
4216145	170 x 225mm	0/CG	100
4216148	200 x 275mm	1/DG	100
4216149	240 x 275mm	2/EG	100
4216150	240 x 350mm	3/FG	100
4216151	250 x 350mm	4/GG	100
4216152	290 x 370mm	5/HG	100
4216153	320 x 445mm	6/JG	50
4216154	370 x 480mm	7/KG	50
4216155	460 x 680mm	8/LG	50



More colours available.  
Custom printing options.  
Please ask our sales team  
for details.

### Paper Mailers

- Eco-friendly, hard wearing kraft paper mailers
- Recyclable and compostable
- Double fix closure options, ideal for returns
- Peel and seal closure fixings



**New!**



Need a different size? Bespoke sizing & custom printing available

#### Single Fix

Item Code	Size	Flap & Fix	Per Pack
4216166	190 x 50 x 300mm	50mm Single	300
4216167	250 x 50 x 353mm	50mm Single	300
4216168	260 x 70 x 410mm	50mm Single	300
4216169	300 x 80 x 430mm	50mm Single	300
4216170	360 x 100 x 560mm	50mm Single	200

#### Double Fix

Item Code	Size	Flap & Fix	Per Pack
4216175	190 x 50 x 300mm	110mm Double	300
4216176	250 x 50 x 353mm	110mm Double	300
4216177	260 x 70 x 410mm	110mm Double	300
4216178	300 x 80 x 430mm	110mm Double	300
4216179	360 x 100 x 560mm	110mm Double	200

**Book Wraps with Tape Strip**

- Single wall corrugated board
- Ripper strip for easy opening
- Self seal, peel and seal closure fixing
- Recyclable
- Compostable with strip removed



Item Code	Size (Internal)	Size Ref	Unit
4916851	235 x 157 x 60mm	A5	25
4916854	300 x 232 x 47mm	A4	25
4916855	327 x 270 x 47mm	A4 Large	25
4916744	300 x 250 x 70mm	A4 Deep	25
4916811	420 x 320 x 100mm	A3	20
4916852	620 x 456 x 70mm	A2	25

With self seal strip and ripper strip for opening

**Board Backed Manilla Envelopes**

- Pre-printed "Please do not bend"
- Self seal tape strip



Item Code	Size	Size Ref	Unit
1039083	162 x 114mm	C6	250
1039016	229 x 162mm	C5	125
1039015	324 x 229mm	C4	125
1039020	458 x 324mm	C3	100

**Capacity Envelopes with Tape Strip**

- Corrugated board envelopes, suitable for books
- Ripper strip for easy opening
- Self seal tape strip



Item Code	Size	Size Ref	Unit
1039087	234 x 178mm	A5	50
1039088	291 x 194mm	A5 Large	50
1039089	333 x 233mm	A4	50
1039090	349 x 249mm	A4 Large	50

**Postal Envelopes**

- White paper postal envelopes
- Regular or 'pocket' (opening at short end)
- Address window options
- Self seal tape strip



Item Code	Size/Description	Size Ref	Unit
1039012	99 x 210mm	DL	1000
1039110	99 x 210mm - Window	DL	1000
1039067	229 x 162mm	C5	500
1039037	229 x 162mm - Pocket	C5	500
1039023	324 x 229mm	C4	250

**Coloured Postal Envelopes**

- Various styles and colours available
- Contact us for more details



Ask our sales team for more stationary options

**Solid Board Envelopes**

- White board envelopes, ideal for calendars
- Ripper strip for easy opening
- Self seal tape strip
- Compostable with strip removed



Item Code	Size	Unit
1039082	170 x 302mm	100
1039081	349 x 449mm	100

**Marker Pens**

- Permanent black ink marker pens
- Bullet or chisel tip



Item Code	Type	Per Pack
1039009	N50 Bullet Tip	12
1039011	N60 Chisel Tip	12

**Polythene Mailing Bags**

- Grey opaque mailing bags
- 100% recycled polythene
- Self-seal 40mm lip, permanent adhesive
- Durable and water resistant
- Made with recycled content



Bespoke mailers can be made to your exact requirements, sized perfectly and custom printed with your messages.

Please contact our sales team.



**Plain Bags**

Item Code	Size (mm)	Size (in)	Unit
3316001	170 x 230	6 x 9	2000
3316002	230 x 310	9 x 12	1000
3316003	250 x 300	10 x 12	1000
3316004	250 x 350	10 x 14	1000
3316005	300 x 350	12 x 14	1000
3316006	320 x 440	12.5 x 17	1000
3316007	350 x 400	14 x 16	500
3316008	350 x 550	14 x 21	500
3316009	400 x 525	16 x 21	500
3316010	425 x 600	17 x 24	500
3316011	525 x 600	21 x 24	250
3316012	550 x 750	22 x 29.5	250
3316013	600 x 700	24 x 27.5	500
3316014	700 x 850	27.5 x 33.5	200
3316015	850 x 980	33.5 x 38.5	150
3316016	850 x 1050	33.5 x 41.5	100

**PWN Bags - with Printed Warning Notice**

Item Code	Size (mm)	Size (in)	Unit
3316046	161 x 240	6 x 9.5	2000
3316039	250 x 350	10 x 14	1000
3316048	300 x 350	12 x 14	1000
3316049	350 x 400	14 x 16	1000
3316036	400 x 525	16 x 21	500
3316050	525 x 600	21 x 24	500
3316037	600 x 700	24 x 27.5	500
3316045	700 x 800	27.5 x 32	250
3316038	830 x 1060	32.5 x 42	200

**CAN'T SEE  
WHAT YOU'RE  
LOOKING FOR?**



Give our sales team a call on  
**08000 540 100**

Ask us about clear and coloured mailing bags

**Paper Document Enclosed Wallets**

- Plain or pre-printed paper "Documents Enclosed" wallets
- Fully constructed from paper/card and 100% recyclable
- Eco-friendly alternative to plastic wallets



100% paper construction.  
Can be recycled along with the  
box they are attached to.

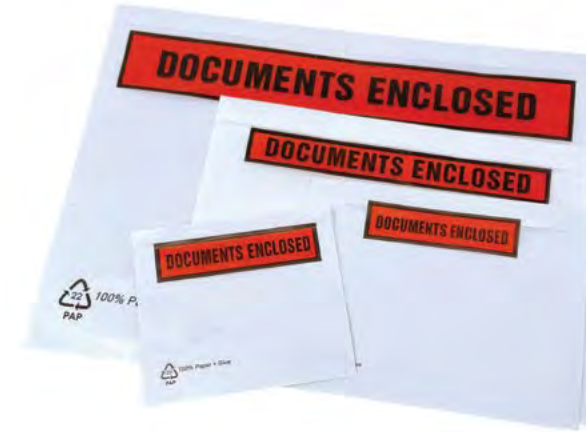

**Plain**

Item Code	Size	Size Ref	Unit
3416020	123 x 110mm	A7	1000
3416021	240 x 135mm	DL	1000
3416022	175 x 135mm	A6	1000
3416023	240 x 180mm	A5	1000
3416024	330 x 245mm	A4	500

**Pre-Printed "DOCUMENTS ENCLOSED"**

Item Code	Size	Size Ref	Unit
3416025	123 x 110mm	A7	1000
3416026	240 x 135mm	DL	1000
3416027	175 x 135mm	A6	1000
3416028	240 x 180mm	A5	1000
3416029	330 x 245mm	A4	500

### Single Wall Cartons

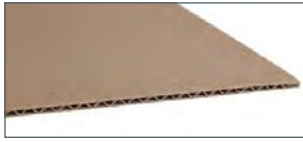

- Single wall, B flute
- Unit is each
- Sold in packs of 25



Cartons can be made to your exact requirements and custom printed

Item Code	Size (LxWxD) in	Size (LxWxD) mm
6316001	4 x 4 x 4	102 x 102 x 102
6316002	5 x 5 x 5	127 x 127 x 127
6316003	6 x 6 x 6	152 x 152 x 152
6316004	7 x 7 x 7	178 x 178 x 178
6316005	8 x 6 x 4	203 x 152 x 102
6316006	8 x 6 x 6	203 x 152 x 152
6316007	8 x 8 x 8	203 x 203 x 203
6316008	9 x 6 x 6	229 x 152 x 152
6316009	9.5 x 9.5 x 4.5	241 x 241 x 114
6316010	9 x 9 x 9	229 x 229 x 229
6316011	10.5 x 9.5 x 4	267 x 241 x 102
6316012	12 x 9 x 3	305 x 229 x 76
6316013	12 x 9 x 4	305 x 229 x 102



### Double Wall Cartons



- Double wall, BC flute
- Unit is each
- Sold in packs of 15



Need a different size?  
We can make to your specs

† Vari-Depth Carton

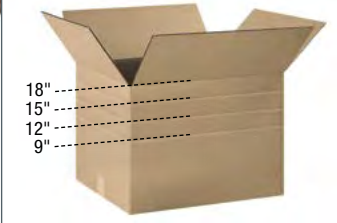

Item Code	Size (LxWxD) in	Size (LxWxD) mm	Item Code	Size (LxWxD) in	Size (LxWxD) mm
6416002	9 x 6 x 6	229 x 152 x 152	6416029	12 x 9 x 3	305 x 229 x 76
6416003	10 x 10 x 10	254 x 254 x 254	6416028	12 x 9 x 12	305 x 229 x 305
6416004	12 x 9 x 5	305 x 229 x 127	6416043	18 x 12 x 6	457 x 305 x 152
6416005	12 x 9 x 6	305 x 229 x 152	6416017	20 x 20 x 20	508 x 508 x 508
6416006	12 x 9 x 9	305 x 229 x 229	6416018	23 x 15 x 13.5	584 x 381 x 343
6416007	12 x 12 x 12	305 x 305 x 305	6416019	23 x 11 x 14.5	584 x 279 x 368
6416008	14 x 10.25 x 12	356 x 260 x 305	6416020	22.25 x 14 x 14.5	565 x 356 x 368
6416009	14 x 14 x 14†	356 x 356 x 356†	6416021	22.25 x 14 x 22	565 x 356 x 559
6416010	16 x 16 x 16	406 x 406 x 406	6416022	24 x 18 x 18†	610 x 457 x 457†
6416011	18 x 12 x 10	457 x 305 x 254	6416023	24 x 24 x 24†	610 x 610 x 610†
6416012	18 x 12 x 12†	457 x 305 x 305†	6416024	30 x 18 x 12	762 x 457 x 305
6416014	18 x 18 x 12†	457 x 457 x 305†	6416025	30 x 18 x 18†	762 x 457 x 457†
6416013	18 x 18 x 18†	457 x 457 x 457†	6416026	30 x 20 x 20	762 x 508 x 508
6416015	18 x 18 x 20	457 x 457 x 508	6416027	36 x 36 x 36	914 x 914 x 914
6416016	18 x 18 x 30	457 x 457 x 762			

† Vari-depth

### Corrugated Board Flute Examples

Our boxes are available in various flutes. Ask our sales team and request samples.

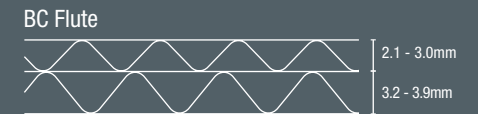

Samples available on request

**Ecommerce Postal Boxes**

- Designed for ease of use at Royal Mail delivery sizes
- Quick assembly with easy-fold self locking mechanism
- Supplied flat and pre-printed with size, barcode and SKU/item code
- Ideal for ecommerce retailers



Quick and easy assembly.  
No tape required

**Large Letter - Depth 20mm**

Item Code	Size (LxWxD) mm	Unit	Min. Order
7416100	101 x 101 x 20	Each	50
7416010	112 x 163 x 20	Each	50
7416012	217 x 108 x 20	Each	50
7416101	218 x 159 x 20	Each	50
7416102	320 x 230 x 20	Each	50



**Small Parcel - Depth 51mm**

Item Code	Size (LxWxD) mm	Unit	Min. Order
7416110	180 x 102 x 51	Each	50
7416111	215 x 152 x 51	Each	50
7416112	310 x 220 x 51	Each	50



**Small Parcel - Depth 60-75mm**

Item Code	Size (LxWxD) mm	Unit	Min. Order
7416120	102 x 80 x 60	Each	50
7416130	152 x 102 x 70	Each	50
7416131	203 x 140 x 76	Each	50
7416009	415 x 337 x 70	Each	25

- 7416131 - suitable for 35cm x 25cm DPD bag



**Small Parcel - Depth 80mm**

Item Code	Size (LxWxD) mm	Unit	Min. Order
7416141	127 x 102 x 80	Each	50
7416140	160 x 80 x 80	Each	50
7416142	270 x 180 x 80	Each	50

**Small Parcel - Depth 100mm+**

Item Code	Size (LxWxD) mm	Unit	Min. Order
7416150	200 x 102 x 102	Each	50
7416151	254 x 203 x 102	Each	50
7416152	300 x 250 x 100	Each	50
7416016	450 x 350 x 158	Each	25

- 7416152 - suitable for 52cm x 38.5cm DPD bag



See these boxes online



We can help you choose the most suitable box sizes for all your items

Easily re-order more. Our ecommerce boxes are supplied with pre-printed size, SKU/item code and barcode

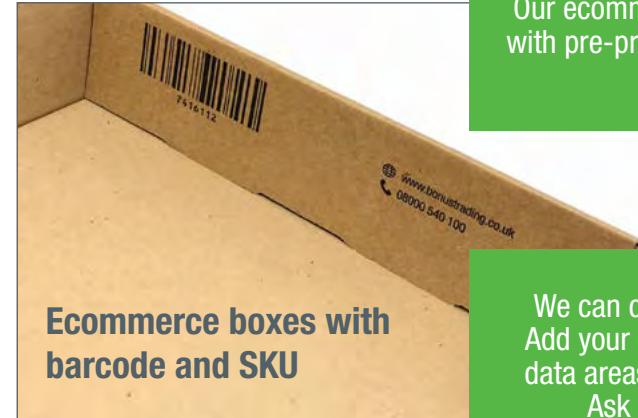

Ecommerce boxes with barcode and SKU

We can custom print your boxes. Add your own barcodes, branding, data areas and useful information. Ask us for more details.

Reducing the use of plastic polyprop tapes is better for the environment and makes recycling boxes easier

**White Easy-Fold Postal Boxes**

- Single wall with white outer
- Quick assembly with easy-fold self locking mechanism
- Supplied flat



Quick and easy assembly.  
No tape required



See our great selection of ecommerce boxes on page 46

Item Code	Size (LxWxD) mm	Unit	Min. order
7416001	100 x 80 x 60	Each	50
7416002	120 x 100 x 80	Each	50
7416003	150 x 150 x 60	Each	50
7416004	170 x 140 x 55	Each	50
7416005	200 x 100 x 100	Each	50
7416006	250 x 150 x 50	Each	50
7416007	305 x 152 x 50	Each	50
7416008	300 x 250 x 100	Each	50

**Archive Boxes**

- No tape or fixings required
- Heavy duty
- Quick assembly
- Re-useable & easy to collapse
- Double glue seam providing integrity & strength
- No staples
- Includes hand grip holes
- 100% recyclable
- Compact to store
- Pre-assembled lid
- Crash lock base
- Keeps archive files safe in storage
- Ideal for solicitors, accountants, architects and planning departments



No tape required, easy to assemble

Ask our sales team about archive boxes, we can supply to order

**BDCM Cartons**

- High quality 'Bulk Distribution Carton Metric' boxes
- Pre-printed with standard information panels in blue
- Strong single wall construction
- 7816010 is double wall
- 7816009 is unprinted



Item Code	Type	Size (LxWxD) in	Size (LxWxD) mm
7816001	BDCM1	23.5 x 12 x 15	595 x 295 x 388
7816010	BDCM1 Double Wall	23 x 11 x 15	587 x 283 x 375
7816002	BDCM2	16 x 12 x 16	400 x 300 x 400
7816003	BDCM4	15.5 x 11.5 x 7.5	394 x 292 x 191
7816004	BDCM3	23.5 x 11.5 x 7.5	597 x 292 x 190
7816009	BDCM3 Blank	23.5 x 11.5 x 7.5	597 x 292 x 190

**Pallet Boxes**

- Ideal protection for shipping heavy loads
- Strong cardboard tray, sleeve and cap
- Supplied flatpacked to save space
- Some include pallet with tray attached
- Easy to assemble



Supplied flatpacked



Item Code	Type	With pallet	Size (LxWxD) in	Size (LxWxD) mm
6916030	Europa Pallet Box	No	46 x 30 x 39.5	1170 x 770 x 1000
6916017	Half Europa Pallet Box	Yes	30 x 22.5 x 26	770 x 570 x 660
6916003	Europa Pallet Box	Yes	42 x 34 x 21.5	1075 x 870 x 550
6916012	D/W Standard Pallet Box	Yes	47.5 x 43.5 x 36	1210 x 1010 x 920
6916022	1/1 Europa Pallet Box	Yes	46 x 30 x 26	1170 x 770 x 660

**Small Bubble Wrap**

- Clear film wrap with small bubbles
- Made with min. 30% recycled content
- 100 metre length rolls
- Recyclable



Small  
10mm

Item Code	Width	Type	Unit
4316023	300mm	Recycled 30%	5 rolls
4316024	500mm	Recycled 30%	3 rolls
4316026	600mm	Recycled 30%	2 rolls
4316027	750mm	Recycled 30%	2 rolls
4316029	900mm	Recycled 30%	Roll
4316013	1000mm	Recycled 30%	Roll
4316014	1200mm	Recycled 30%	Roll
4316018	1500mm	Recycled 30%	Roll
4316021	1800mm	Recycled 30%	Roll
4316022	2000mm	Recycled 30%	Roll

**Large Bubble Wrap**

- Clear film wrap with large bubbles
- Made with min. 30% recycled content
- 50 metre length rolls
- Recyclable



Large bubble  
20mm

Item Code	Width	Type	Unit
4316004	300mm	Recycled 30%	5 rolls
4316006	500mm	Recycled 30%	3 rolls
4316007	600mm	Recycled 30%	2 rolls
4316008	750mm	Recycled 30%	2 rolls
4316001	1000mm	Recycled 30%	Roll
4316002	1200mm	Recycled 30%	Roll
4316003	1500mm	Recycled 30%	Roll

**Bubble wrap size guide**

All of our bubble wrap range is now made with a minimum of 30% recycled content

**PLEASE NOTE**  
Wraps and films made with recycled content can appear to have a light grey tint

**Jiffy® Small Bubble Wrap**

- Made with min. 30% recycled content
- 100 metre length rolls
- Recyclable
- Jiffy brand



Small  
10mm

Item Code	Width	Type	Unit
4316038	300mm	Jiffy	5 rolls
4316054	600mm	Jiffy Easy Tear	2 rolls
4316050	750mm	Jiffy Easy Tear	2 rolls
4316028	750mm	Perforated Jiffy (300mm)	2 rolls
4316039	1200mm	Jiffy Easy Tear	Roll
4316057	1500mm	Jiffy	Roll

**Wrap roll unit bundle examples**

Some widths are supplied as pre-cut wider rolls, resulting in unit bundles of 2, 3 or 5 narrower rolls



**Jiffy® Large Bubble Wrap**

- Clear film wrap with large bubbles
- Made with min. 30% recycled content
- 50 metre length rolls
- Jiffy brand



Large bubble  
20mm

Item Code	Width	Type	Unit
4316056	500mm	Jiffy Easy Tear	3 rolls
4316048	750mm	Jiffy Easy Tear	2 rolls
4316061	1200mm	Jiffy Easy Tear	Roll
4316053	1500mm	Jiffy	Roll

**Bubble Pouches Clear**

- Clear bubble film pouches
- Made with recycled content



Item Code	Size	Size Ref	Unit
4216038	100 x 135mm	BB1	750
4216039	130 x 185mm	BB2	500
4216040	180 x 235mm	BB3	300
4216041	230 x 285mm	BB4	300
4216042	280 x 360mm	BB5	150
4216043	305 x 435mm	BB6	150
4216044	380 x 435mm	BB7	100
4216045	500 x 750mm	BB8	50
4216076	510 x 770mm	BB9	125

**Bubble Wrap Dispenser Stand**

- Smooth dispensing baseplate design
- Easy unrolling of wrap
- Keeps roll tidy and off the floor
- Prevents wrap from being scuffed or damaged
- Robust and heavy duty metal construction
- Powder coated red
- Adjustable feet for great stability
- Quick and easy roll changes
- Holds roll upright, saving space

**New!**

Item Code	Description
6616166	Bubble Wrap Dispenser Stand



Find bubble wrap on page 50



Ask us for a demo of our top sheet and bubble wrap dispensers



Top sheet dispenser also available. See page 74



**Postal Tubes**

- Sturdy cardboard tubes with plastic end caps
- Tubes are recyclable and compostable
- End caps are recyclable
- Ideal for posters, maps and fabrics



**Tubes with End Caps**

Item Code	Length	Diam	Wall	Fits	Unit
5616033	330mm	38mm	1.5mm	A3	Each
5616047	330mm	50mm	1.5mm	A3	Each
5616057	450mm	38mm	1.5mm	A2	Each
5616032	450mm	50mm	1.5mm	A2	Each
5616058	450mm	63mm	2mm	A2	Each
5616095	450mm	76mm	1.5mm	A2	Each
5616064	538mm	76mm	2.5mm	B2	Each
5616020	624mm	50mm	1.5mm	A1	Each
5616059	632mm	63mm	2mm	A1	Each
5616060	632mm	76mm	2.5mm	A1	Each
5616065	745mm	50mm	1.5mm	B1	Each
5616066	757mm	76mm	2.5mm	B1	Each
5616067	757mm	101mm	3mm	B1	Each
5616061	891mm	76mm	2.5mm	A0	Each
5616062	891mm	101mm	3mm	A0	Each
5616063	891mm	152mm	3mm	A0	Each
5616068	1050mm	76mm	2.5mm	B0	Each
5616069	1050mm	101mm	3mm	B0	Each
5616070	1050mm	152mm	3mm	B0	Each

**Packs of End Caps**

Item Code	Diam	Unit	Min. Order
5616013	76mm	Each	200
5616015	90mm	Each	100



Need a different size? We can supply bespoke tubes to suit your requirements. Ask our sales team

### Foam Edge Protectors L Channel Green

- L-channel green foam lengths
- 100% recycled, 100% recyclable
- Ideal protection for sheet materials and frames

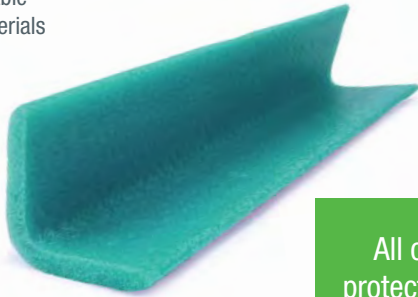

All of our foam edge protectors are now 100% recycled green foam



**L-channel**

Item Code	Size Ref	Internal Size	Length	Metres/Box	Unit
4416074	L50	50mm	2m	480m	Box
4416075	L75	75mm	2m	210m	Box

### Foam Edge Protectors U Channel Green

- U-channel green foam lengths
- 100% recycled, 100% recyclable
- Ideal protection for sheet materials and frames



**U-channel**

Item Code	Size Ref	Internal Size	Length	Metres/Box	Unit
4416069	U15	0-15mm	2m	500m	Box
4416070	U25	15-25mm	2m	280m	Box
4416071	U35	25-35mm	2m	180m	Box
4416072	U45	35-45mm	2m	160m	Box
4416073	U60	45-60mm	2m	100m	Box

### Foam Edge Corners Green

- U-channel foam corners
- 100% recycled, 100% recyclable
- Ideal protection for sheet materials and frames



Item Code	Size Ref	Internal Size	Corners/Box	Unit
4416064	U15	0-15mm	900	Box
4416065	U25	15-25mm	600	Box
4416066	U35	25-35mm	400	Box
4416067	U45	35-45mm	300	Box
4416068	U60	45-60mm	200	Box

### Corrugated Edge & Corner Protection

- 100% paper based, corrugated cardboard edges
- Great alternative to foam and plastic
- Eco friendly protection and cushioning
- Can be made to order, ask our team



Contact us about corrugated edge protection. We can supply and design to suit your requirements.

100% paper protection. A greener alternative to plastic foam edges. Recyclable and compostable.



### Plastic Corner Protectors

- Providing extra protection for items like panels and frames
- Expandable corner options
- Made with 100% recycled material
- Recyclable



Item Code	Size / Description	Unit
4016028	16-40mm Expandable	1000
4016020	60 x 60 x 15mm Closed	1000
4016021	60 x 60 x 18mm Closed	1000
4016022	60 x 60 x 22mm Closed	850
4016023	60 x 60 x 28mm Closed	700
4016378	60 x 60 x 28mm Closed Heavy Duty	800
4016379	60 x 60 x 40mm Closed	600

### Plastic Strapped Edge Protectors

- Edge protection preventing strapping from digging into the packaging
- Size options for use with straps up to 19mm or up to 30mm in width
- Made with 100% recycled material
- Recyclable



Item Code	Description	Unit
4016025	28 x 25mm (up to 19mm strap)	2000
4016024	37 x 32mm (up to 30mm strap)	1000

Extra protection for edges when using strapping. See strapping from page 76

### Solid Board Edge Protectors

- Sturdy cardboard edge protection
- Prevent damage to load edges
- Protect pallets in storage and transit
- Use with strapping or wrap to secure pallet contents
- 100% cardboard, compostable and recyclable



Item Code	Size	Length	Wall	Unit
4716025	25 x 25mm	1.9m	4mm	Each
4716015	35 x 35mm	0.2m	3mm	Each
4716032	35 x 35mm	0.5m	2mm	Each
4716009	35 x 35mm	1m	3mm	Each
4716003	35 x 35mm	1.5m	3mm	Each
4716026	35 x 35mm	1.8m	2mm	Each
4716012	35 x 35mm	2m	3mm	Each
4716030	50 x 50mm	0.9m	4mm	Each
4716004	50 x 50mm	1m	3mm	Each
4716027	50 x 50mm	1.2m	3mm	Each
4716021	50 x 50mm	1.3m	4mm	Each
4716006	50 x 50mm	1.5m	3mm	Each
4716007	50 x 50mm	1.8m	3mm	Each
4716020	50 x 50mm	1.8m	4mm	Each
4716008	50 x 50mm	2m	3mm	Each
4716013	75 x 75mm	2m	6mm	Each
4716014	80 x 80mm	1.2m	4mm	Each

100% paper based. Compostable and recyclable.

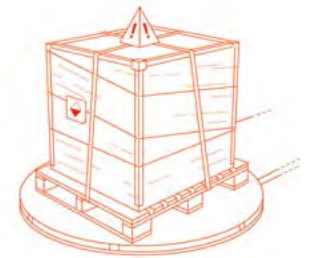

Find our load protection guides on page 10

**Pallet Cones "Do Not Stack"**

- Protect pallet loads from being stacked
- Attach to pallets while applying strapping
- Pre-printed with "DO NOT STACK"
- Corrugated cardboard, recyclable and compostable
- Supplied flatpacked, easy assembly
- Custom printing available, with your branding



Ask us about custom designing your own branded pallet cones



Item Code	Size	Pack Qty
4016382	200mm high approx	25

**Cardboard Layer Pads**

- Add cardboard sheets between goods
- Protect surfaces and improve load stability
- Single wall



Ask us about bespoke sizes

Item Code	Size	Unit	Min. Order
3716387	605mm x 605mm	Each	1616
3716362	800mm x 1200mm	Each	450
3716014	1000mm x 1200mm	Each	450

**Wooden Pallets**

- Robust pallets
- New or used
- Used sizes may vary slightly



We can supply bespoke sizes



Item Code	Description
4016354	800 x 600mm Half Euro (seconds)
4016368	1200 x 800mm Standard Euro
4016350	1200 x 800mm Grade1 Euro Stamped
4016381	1200 x 800mm Heat Treated Euro
4016351	1200 x 800mm Lightweight Euro
4016355	1200 x 1000mm Standard Pallet
4016356	1200 x 1000mm Grade1 (width way slats)
4016383	2400 x 1200mm Lightweight Pallet 4 Way

**Corrugated Paper Rolls**

- Provides a layer of surface protection
- Ideal for separating individual items
- Made from recycled materials
- 75 metre length rolls



**MG Pure Ribbed Kraft Paper**

- For medium and heavy duty packing
- Kraft paper, virgin material



Item Code	Width	Length	Weight	Unit
3816019	450mm	285m	70gsm	Roll
3816020	500mm	285m	70gsm	Roll
3816021	600mm	285m	70gsm	Roll
3816022	750mm	285m	70gsm	Roll
3816023	900mm	285m	70gsm	Roll
3816024	900mm	225m	88gsm	Roll
3816017	1150mm	220m	88gsm	Roll

**Reams - supplied flat**

3816018	900mm	1150mm	90gsm	250 sheets
---------	-------	--------	-------	------------



We can supply bespoke paper and card sizes. Ask our team.

Item Code	Width	Length	Unit
4616020	325mm	75m	Roll
4616012	600mm	75m	Roll
4616015	650mm	75m	Roll
4616013	750mm	75m	Roll
4616014	900mm	75m	Roll
4616017	1100mm	75m	Roll
4616002	1200mm	75m	Roll
4616004	1500mm	75m	Roll
4616005	1800mm	75m	Roll

**MG Imitation Kraft Paper**

- For medium and heavy duty packing
- Imitation kraft paper, recycled material



Item Code	Type	Width	Length	Weight	Unit
3816008	Plain	600mm	200m	90gsm	Roll
3816009	Plain	750mm	200m	90gsm	Roll
3816010	Plain	900mm	200m	90gsm	Roll
3816031	Plain	1150mm	225m	90gsm	Roll

### Tissue Paper

- Protect and separate delicate items
- MG tissue is high quality acid free
- Many more colours available to match your brand



Ask us about bespoke sizes and custom printing



More colours available

Item Code	Description	Colour	Size	Weight	Sheets Per Ream/Unit
3816004	Standard Tissue	Off White	750mm x 500mm	18gsm	480
3816029	Acid Free Tissue	White	750mm x 500mm	18gsm	480
3816037	Acid Free MG Tissue	White	700mm x 450mm	18gsm	480
3816027	Acid Free Tissue	Red	750mm x 500mm	16gsm	480
3816028	Acid Free Tissue	Black	750mm x 500mm	16gsm	480

### News Off Cuts

- Unprinted newsprint paper
- Ideal for wrapping ceramics and glass
- Approx. 550 sheets per pack



See paper wrap and void fill from page 62

Paper based wraps and void fill are environmentally friendlier and sustainable



Item Code	Width	Length	Unit
3816015	500mm	750mm	10kg pack

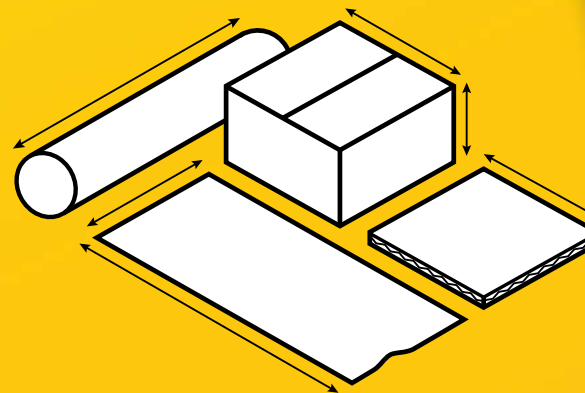

## CUSTOM SIZES & PRINTING

### THE PERFECT PACKAGING

Boxes, tubes, sheet papers and rolls available in bespoke sizes, with dimensions to suit your products.

Use the most efficient sized packaging for optimal space saving during storage, transport and delivery.

You can also add printed branding, icons or messages to any size packaging you need. Ask our sales team for details of all our available options.



### Grip® PaperFill Void Fill

- Grip PaperFill void fill boxes and stand
- Height adjustable tray, for easy dispensing
- Attach to any workbench, adjustable to any angle
- Robust, high quality, powder coated steel



Ask us about free stand hire  
Subject to min. order terms



- Easy-open box contains single ply void fill
- Roll 375mm x 350m, 65gsm
- Recycled and recyclable



See Grip® PaperFill in action  
Watch the video at [bonustrading.co.uk](http://bonustrading.co.uk)

Item Code	Description
4516033	Grip PaperFill Void Fill Box

Book live demos with us



### Grip® PaperFlex

- 100% paper honeycomb protective wrap
- 390mm wide x 250m long (unopened)
- Up to 400m long when honeycomb is opened
- 90gsm kraft coloured paper
- Use with Grip Stack or Bench dispenser
- Recyclable and compostable paper



Item Code	Description
3816061	Grip PaperFlex Roll - 390mm



Use with the Stack or Bench dispenser

New!

### Grip® Stack

- Dispenser station for paper wrap, void fill & tape
- Stand comes supplied with PaperFill dispenser arm
- Add other dispenser arms as needed
- Space saving and organised
- Position your wrap, void fill and paper tape perfectly in your work area
- Easily adjust arm heights and angles

New!

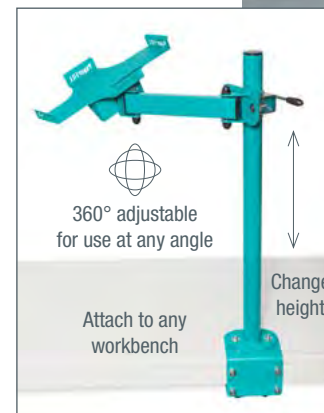

Securely attach to any desktop or work bench

See the Grip Taper dispenser on page 33

Item Code	Description
7716032	Grip Stack Stand (pole only)
7716024	Grip Stack Stand and PaperFill Void Fill Arm
7716026	Grip Taper Dispenser Arm
7716027	Grip PaperFlex Dispenser Arm

### Grip® PaperFlex Bench Dispenser

- Robust metal frame and grippy feet
- Set the perfect tension with twist-lock mechanism

Item Code	Description
7716033	Grip PaperFlex Bench Dispenser



### Ri-Fill Paper Void Fill

- 100% recyclable paper void fill and cushioning
- Free machine hire, ask us for more details
- Create sturdy and secure void fill and cushioning
- Protect items during storage and transit
- Ri-Fill dispenser machine creates void fill and cushioning
- Dispenser can be set to cut at pre-set lengths automatically
- Easy operation, supplied with foot peddle



Ri-Fill 3 Dispenser

Free machine hire with fully inclusive maintenance package



Contact our team to book a free on-site demo and void fill audit.

Item Code	Description	Width	Length	Unit
4516018	Ri-Fill Paper Void Fill - 85gsm	400mm	400m	Roll
6616112	Ri-Fill 3 Paper Void and Cushioning Machine	-	-	Each

Ri-Fill is 100% paper and is ideal for creating fill, padding & cushioning. Protect your products and help protect the environment. Recyclable and compostable.



### Ri-Fill Paper Void Fill & Cushioning



**Contact us to book a free demo & training.**  
Keep the machine for a week to fully trail and test!  
We supply everything, incl. stock of paper samples.

See online

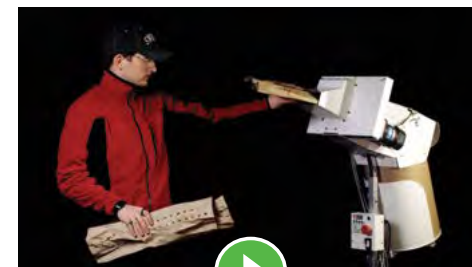
**Watch the Ri-Fill dispenser in action**  
See the video at [bonustrading.co.uk](http://bonustrading.co.uk) or book a live demo with us



Create protective cushioning and padding to secure and stabilise your parcel contents

#### Tips for using paper void fill

- Keep the paper together, rather than using lots of smaller pieces.
- Coiling the paper can offer extra strength, support and performance.
- Placing a paper pad in to the box before the product will provide extra protection.

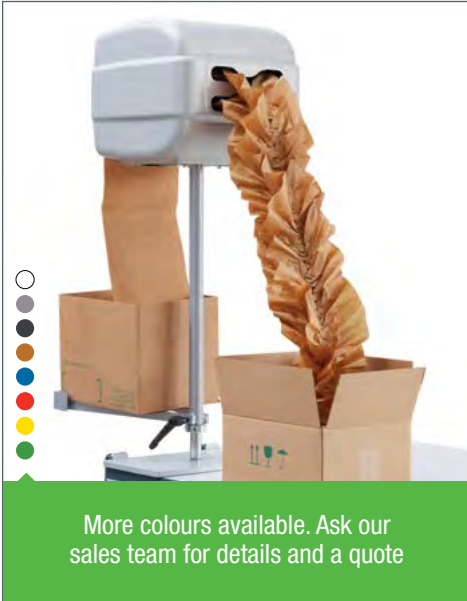

### Papillon Paper Void Fill

- For use with Papillon Void Fill machines
- Brown - 2.24m<sup>3</sup> per box. Black - 2.5m<sup>3</sup> per box



Item Code	Description	Colour	Width	Length	Unit
4516001	P/P Void Fill	Brown	200mm	280m	Box
4516005	P/P Void Fill	Black	200mm	320m	Box

Thanks to its special, patented shape, the paper cushioning of the PAPERplus® Papillon system offers optimal protection for small and medium-sized shipping goods. It's suitable for filling voids and wrapping products, boasts large volume at a low weight, and is especially soft and flexible.

Item Code	Description	Power
6616041	Papillon Void Fill Machine	240v ~

### Classic Paper Void Fill

- Classic kraft paper roll



Item Code	Description	Width	Length	Unit
4516003	Classic Void Fill	610mm	325m	Roll

The Classic machine processes rolls of kraft paper and recycled paper into padding for protective packaging of medium-weight to heavy-weight products.

- Nine modes of operation
- Produce pads on-demand or program for multiple stations and/or multiple orders
- Unit lock-out capability
- Continuous adjustable operating speed
- Electronically adjustable machine height
- Touch panel operation, moveable control pad
- Effortless mobility for station and set-up changes



Available with table stand, table top stand (bench) or floor stand

Item Code	Description	Power
6616064	Classic Void Fill Machine	240v ~

### Paper Void Fill Dispenser

- Cost effective on-demand void fill for low to medium usage
- Rugged construction
- Can be bench or wall mounted; weighs 6.8kg
- Paper roll braking system prevents over-run
- Integral rip jaws for fast and easy tearing



Item Code	Description	Weight
7716010	Void Fill Dispenser	6.8kg

### Bio Loose Fill

- Good protection for fragile items
- Biofil - Reusable / Biodegradable



Item Code	Description	Unit
6016001	0.425m <sup>3</sup> Biofil Bag	Each

### Cardboard Shredders

- Reuse old boxes as void fill and matting
- Reduce plastic void fill use
- 2yr standard warranty
- C400 - desktop shredder, medium capacity, 10mm infeed, single phase (AC)
- P425 - freestanding shredder, high capacity, 20mm infeed, single or three phase options, optional dust vacuum (requires adaptor)



Item Code	Description
6616250	C400 Shredder - Single phase



Item Code	Description
6616251	P425 Shredder - Single Phase
6616252	P425 Shredder - Single Phase + Adaptor
6616253	P425 Shredder - Three Phase
6616254	P425 Shredder - Three Phase + Adaptor
6616255	P425 Shredder Dust Extractor Vacuum

### Blue Ocean Air Pillows Protective Void Fill

- Air pillows, cushions, padding and void fill
- Light weight protection, saving fuel during shipping
- 100% recycled content, class 4 material
- Fully recyclable
- Space saving before use, rolls take up little space
- Easily inflate to create air filled pillows and cushions using the Blue Ocean air machine
- Free machine hire while regularly ordering film, ask for more details



- Made from 100% recycled plastic, grade 4 LDPE (Low-density Polyethylene), closed loop post-consumer waste, high quality, reduced carbon footprint.



100% recycled film, grade 4. Responsibly sourced, clean post-consumer material



Free machine hire



Item Code	Description	Width	Height	Roll Length	Unit
3216034	Blue Ocean Pillow Void Fill Film	200mm	150mm	1000m	Roll
3216024	Blue Ocean Pillow Void Fill Film	275mm	200mm	750m	Roll
3216025	Blue Ocean Pillow Void Fill Duo Film	400mm	150mm	250m	Roll
3216042	Blue Ocean Pillow Tube Void Fill Film	400mm	100mm	250m	Roll
3216038	Blue Ocean Quilt/Cushion Large 16 Cell	436mm	245mm	250m	Roll
3216046	Blue Ocean Quilt/Cushion Small 16 Cell	436mm	197mm	250m	Roll
3216040	Blue Ocean Square Bubble Wrap	432mm	197mm	250m	Roll
3216044	Blue Ocean Round 35mm Bubble	400mm	150mm	250m	Roll
6616093	Blue Ocean Air Fill Machine	-	-	-	Each

### AIRplus® Air Pillow Film

Light as a feather and reliably shock-resistant, AIRplus® air pillows are the optimal protective packaging for sensitive products. A variety of pillow shapes can be produced directly at the packing station, therefore saving valuable storage space.

All AIRplus® machine types can be integrated into existing packing processes – including in combination with automated packing lines and storage containers at the packing station.

- 50% recycled content
- Lightweight, easy to use
- Free machine hire, ask for details



Free machine hire



Item Code	Type	Width	Height	Roll Length	Unit
3216003	AIRplus Pillow Film	200mm	65mm	1125m	Roll
3216004	AIRplus Pillow Film	200mm	120mm	1125m	Roll
3216005	AIRplus Pillow Film	200mm	175mm	1125m	Roll
3216019	AIRplus Bubble Film	400mm	160mm	500m	Roll
3216015	AIRplus 2 Pillow Film	400mm	150mm	500m	Roll

### AIRplus Excel Air Machine



The AIRplus Excel is the ultimate void fill application machine, for the high volume user. Free machine hire options\*

- Takes all film types up to 400mm width
  - High Speed: 18 metres per minute
  - Pre-programmable control panel
- \*subject to contract*

Item Code	Size (LxWxH)	Power
6616001	520 x 480 x 400mm	240v ~

### AIRplus Mini Air Machine



Ideal packaging system for void fill applications for the medium volume user. Free machine hire options\*

- Compact design, weighs only 11kgs
  - Takes 200m width film - easy to load
  - Speed: 12 metres per minute
- \*subject to contract*

Item Code	Size (Footprint)	Power
6616002	400 x 300mm	240v ~

### Elasticated Corrugated Cardboard Bottle Sleeves

- 100% paper/card material construction
- Corrugated cardboard bottle protection
- No plastic, can be recycled or composted
- Innovative design allows cardboard to stretch for a secure fit
- Folded card expands to fit various sizes and shapes
- Can be used to protect a variety of different items



See online



Other sizes can be supplied, suitable for products such as drinks bottles, cosmetics and even protection for small electrical devices.



100% paper.  
Recyclable and  
compostable.

100% cardboard construction. The innovative folded cardboard design results in a tight fit without any elastic threads.

Item Code	Size	To Fit	Unit	Min. Order
4516015	70-90mm dia. x 270mm + 30mm base fold	Wine bottle	Each	100
4516017	55-65mm dia. x 220mm + 20mm base fold	Beer bottle	Each	150



Talk to us about custom made sleeves for your products and brand. Choose from over 30 colours.

### Biodegradable Bottle Air Bags

- Air protection bags designed for wine bottles
- Can be used for sending other items such as electronic devices
- Made from biodegradable plastic



3216037



3216036



3216035

Item Code	Description	Inflated Bag Dimensions (LxWxH)	Gauge	Unit
3216037	Wine - Bio Treble Bottle Air Bags	100 x 390 x 120mm(x3)	415	100
3216036	Wine - Bio Double Bottle Air Bags	100 x 390 x 120mm(x2)	415	150
3216035	Wine - Bio Single Bottle Air Bags	100 x 390 x 110mm	410	250

### Air Bag Inflating

For medium to high volume requirements, it is recommended to use a suitable air compressor for inflating bags. A manual hand pump is only suggested for low volume, occasional use.

- Compressor has 3.5ltr tank and is supplied with foot pedal and nozzle



6616103

Item Code	Description	Unit
6616102	Small Compressor 3.5ltr - for Air Bags - frequent use	Each
6616103	Small Hand Pump - for Air Bags - occasional use	Each

### Do you need help finding greener alternative products?

- Contact us, we can discuss your options and suggest the best products for you.
- We can carry out a packaging analysis and review your process.
- We'll send out samples and provide on-site or online product demos.

**Clear Polythene Bags**

- Made with 30% recycled plastic
- Recyclable
- Strong plastic film



**100 gauge 25 micron**

Item Code	Size (mm)	Size (in)	Unit
2716251	150 x 200	6 x 8	Box 1000
2716252	175 x 225	7 x 9	Box 1000
2716253	200 x 250	8 x 10	Box 1000
2716254	225 x 300	9 x 12	Box 1000
2716255	250 x 300	10 x 12	Box 1000
2716256	250 x 375	10 x 15	Box 1000
2716257	300 x 375	12 x 15	Box 1000
2716258	300 x 450	12 x 18	Box 1000
2716259	375 x 500	15 x 20	Box 1000
2716260	450 x 600	18 x 24	Box 500
2716261	500 x 750	20 x 30	Box 500
2716262	600 x 900	24 x 36	Box 500
2716263	900 x 1200	36 x 48	Box 250

**200 gauge 50 micron**

Item Code	Size (mm)	Size (in)	Unit
2716264	150 x 200	6 x 8	Box 1000
2716265	175 x 225	7 x 9	Box 1000
2716266	200 x 250	8 x 10	Box 1000
2716267	225 x 300	9 x 12	Box 500
2716268	250 x 300	10 x 12	Box 500
2716269	250 x 375	10 x 15	Box 500
2716270	300 x 375	12 x 15	Box 500
2716271	300 x 450	12 x 18	Box 500
2716272	375 x 500	15 x 20	Box 500
2716273	450 x 600	18 x 24	Box 250
2716274	500 x 750	20 x 30	Box 250
2716275	600 x 900	24 x 36	Box 250
2716276	900 x 1200	36 x 48	Box 100

**400 gauge 100 micron**

Item Code	Size (mm)	Size (in)	Unit
2716277	150 x 200	6 x 8	Box 500
2716278	175 x 225	7 x 9	Box 250
2716279	200 x 250	8 x 10	Box 250
2716280	250 x 300	10 x 12	Box 250
2716281	250 x 375	10 x 15	Box 250
2716282	300 x 375	12 x 15	Box 250
2716283	300 x 450	12 x 18	Box 250
2716284	375 x 500	15 x 20	Box 200
2716285	450 x 600	18 x 24	Box 100
2716286	500 x 750	20 x 30	Box 100
2716287	900 x 1200	36 x 48	Box 50

**Grip Seal Bags - 160 gauge 40 micron**

- Sealable clear polythene bags
- Not food grade



Item Code	Size (mm)	Size (in)	Unit
3116065	150 x 225	6 x 9	Box 1000
3116066	225 x 320	9 x 12.75	Box 1000

**Kraft Paper Bags**

- Eco friendly kraft paper bags
- 100% paper, breathable
- Strung bags, allowing for hanging on a hook



Item Code	Size (mm)	Size (in)	Unit
3816042	215 x 215	8.5 x 8.5	1000
3816043	250 x 250	10 x 10	1000
3816040	330 x 355	13 x 14	1000

**Block Bottom SOS Paper Bags**

- Eco friendly recycled paper bags
- Fold out block bottom, free standing
- 100% paper, breathable



**Brown**

Item Code	Size (mm)	Size (in)	Volume	Unit
3816064	150 x 215 x 310	6 x 8.5 x 12	3.5lb	250
3816065	152 x 215 x 355	6 x 8.5 x 14	5lb	250
3816066	175 x 290 x 345	7 x 11.5 x 13.5	7lb	250
3816067	200 x 315 x 375	8 x 12.5 x 14.5	10lb	250
3816068	200 x 315 x 475	8 x 12.5 x 18.5	14lb	125
3816069	250 x 388 x 413	10 x 15 x 16	21lb	125
3816070	250 x 388 x 550	10 x 15 x 21.5	28lb	125
3816071	310 x 470 x 440	12 x 18.5 x 17	Bucket	350

**White**

Item Code	Size (mm)	Size (in)	Volume	Unit
3816072	76 x 133 x 229	3 x 5 x 9	0.5kg	1000
3816073	108 x 168 x 215	4 x 6.5 x 8.5	1.0kg	1000
3816074	114 x 191 x 311	4.5 x 7.5 x 12	1.5kg	500

**Pallet Top Sheets**

- Protective pallet top sheets and Centre Fold Sheeting
- 30% to 100% recycled
- Recyclable



Item Code	Colour	Dimensions	% Recycled	Micron	Unit
3616049	Clear	900/1800 x 1600mm	30%	20mu	Roll 500
3616032	Clear	1000/2000mm CFS	99%	100mu	100m Roll
3616009	Black	900/1800 x 1800mm	100%	40mu	Roll 150

Ask us about top sheet bundles

Bulk buy deal includes a FREE dispenser!

**Top Sheet Dispenser Stand**

- Smooth dispensing baseplate design
- Easy unrolling of top sheets
- Keeps roll tidy and off the floor
- Prevents top sheets from being damaged, ensuring they remain water tight
- Robust and heavy duty metal construction
- Powder coated red
- Adjustable feet for great stability
- Quick and easy roll changes
- Holds roll upright, saving space



**New!**



Request a demo

Item Code	Description
6616165	Top Sheet Dispenser Stand

Bubble wrap dispenser also available. See page 52

**Polythene Layflat Tubing**

- 25kg max roll weight
- Made with 30% recycled content
- Recyclable
- Not food grade



Made with minimum 30% recycled plastic content



**500 gauge 127 micron**

Item Code	Size (mm)	Size (in)	Approx Length	Weight	Unit
3016063	76	3	165m	3kg	Roll
3016064	102	4	165m	4kg	Roll
3016065	152	6	165m	6kg	Roll
3016066	203	8	165m	8kg	Roll
3016067	254	10	165m	10kg	Roll
3016068	305	12	165m	12kg	Roll
3016069	457	18	165m	18kg	Roll
3016070	610	24	165m	24kg	Roll
3016071	914	36	120m	25kg	Roll



Ask us about more size options. Black tubing also available.

Order by 3pm

Join our mailing list



Next day delivery on all stock items

Receive emails with new products, bulk deals and offers.

Join now at [bonustrading.co.uk](http://bonustrading.co.uk)

We stock quality heat sealers. Ask our team.



### Polypropylene Machine Strapping

- Minimum 30% recycled content
- Recyclable
- 5216003 and 5216005 are embossed



Item Code	Size	Core Size	Colour	Strain
5216003	9mm x 0.55mm x 4000m	200 x 190mm	White	110kg
5216007	12mm x 0.55mm x 3000m	200 x 190mm	White	145kg
5216008	12mm x 0.55mm x 3000m	200 x 190mm	Blue	145kg
5216005	12mm x 0.63mm x 2500m	200 x 190mm	White	170kg
5216009	12mm x 0.63mm x 3000m	200 x 190mm	Blue	170kg
5216022	12mm x 0.63mm x 3000m	200 x 190mm	Black	145kg
5216024	12mm x 0.85mm x 1800m	406 x 150mm	Black	255kg

Ask us about bespoke branded strapping featuring your company name, logo or message

### Polypropylene Hand Strapping

- Supplied on a plastic reel
- Minimum 30% recycled content
- Recyclable



Item Code	Size	Colour	Strain
5116007	12mm x 0.55mm x 2000m	Black	130kg
5116010	12mm x 0.7mm x 1500m	Black	180kg
5116014	12mm x 0.8mm x 1300m	Black	220kg
5116013	12mm x 0.9mm x 1000m	Black	300kg
5116005	12mm x 0.9mm x 1000m	Blue	300kg
5116016	12mm x 0.9mm x 1000m	Yellow	300kg



Need different sizes or colours? Ask our sales advisors

### Paper Strapping

- 100% paper strapping, alternative to plastic
- Eco-friendly, strong and robust
- Use with auto and semi-auto machines
- Compatible with friction weld tools



Watch the video at [bonustrading.co.uk](http://bonustrading.co.uk)



Item Code	Size	Colour	Strain
9916001	12mm x 2000m	Brown	55kg

### Polyester (PET) Strapping

- PET strap is up to 6 times lighter than steel strap
- Highly dense and split resistant
- Excellent weldability
- Good for heavy applications and high tension
- Cardboard core (except 018 & 019 - plastic reel)
- 047, 019 and 044 are embossed strapping



Item Code	Size/Description	Core	Colour	Strain
5416047	12mm x 0.5mm x 2500m - Embossed	406 x 150mm Cardboard	Green	250kg
5416018	12.5mm x 0.55mm x 1600m	Plastic Reel	Green	270kg
5416012	12.5mm x 0.7mm x 2000m	406 x 150mm Cardboard	Green	350kg
5416019	15.5mm x 0.7mm x 1200m - Embossed	Plastic Reel	Green	440kg
5416044	15.5mm x 0.85mm x 1500m - Embossed	406 x 150mm Cardboard	Green	550kg
5416017	19mm x 0.8mm x 1200m	406 x 150mm Cardboard	Green	620kg

See strapping tools and kits from page 80

### Stainless Steel Strapping

- Grade 201 stainless strapping, ribbon wound



Item Code	Size	Wound
5816012	12mm x 0.7mm x 30m	Ribbon
5816019	16mm x 0.7mm x 30m	Ribbon
5816013	19mm x 0.7mm x 30m	Ribbon

### Steel Strapping

- Ribbon wound



- Mill wound

Item Code	Size	Wound	Strain
5816001	13mm x 0.5mm x 1010m	Mill	570kg
5816002	16mm x 0.5mm x 800m	Mill	730kg
5816003	19mm x 0.5mm x 675m	Mill	870kg
5816004	13mm x 0.5mm x 320m	Ribbon	560kg
5816005	16mm x 0.5mm x 332m	Ribbon	720kg
5816007	19mm x 0.5mm x 395m	Ribbon	850kg

### Metal Strapping Seals

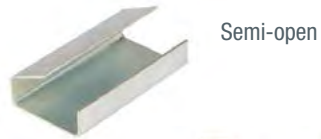

Semi-open



Serrated

Item Code	Type	Size	Unit
5916047	Serrated	12 x 30mm	Box 1000
5916048	Serrated	16 x 30mm	Box 1000
5916050	Semi-open	12 x 32mm	Box 2000
5916054	Semi-open	12 x 25mm	Box 2000
5916052	Semi-open	16 x 32mm	Box 2000

### Metal Strapping Buckles



#### Stainless Steel

Item Code	Type	Size	Unit
5916026	Knockdown	12mm	Box 100
5916027	Knockdown	19mm	Box 100

#### Galvanised

Item Code	Type	Size	Unit
5916031	CB Buckle	13mm	Box 1000
5916032	Sheradised	13mm	Box 1000
5916033	CB Buckle	16mm	Box 1000
5916034	Sheradised	16mm	Box 1000
5916035	CB Buckle	19mm	Box 1000
5916036	Sheradised	19mm	Box 1000
5916037	CB Buckle	25mm	Box 500
5916038	Sheradised	25mm	Box 400
5916029	CB Buckle	35mm	Box 250
5916030	Sheradised	35mm	Box 1000

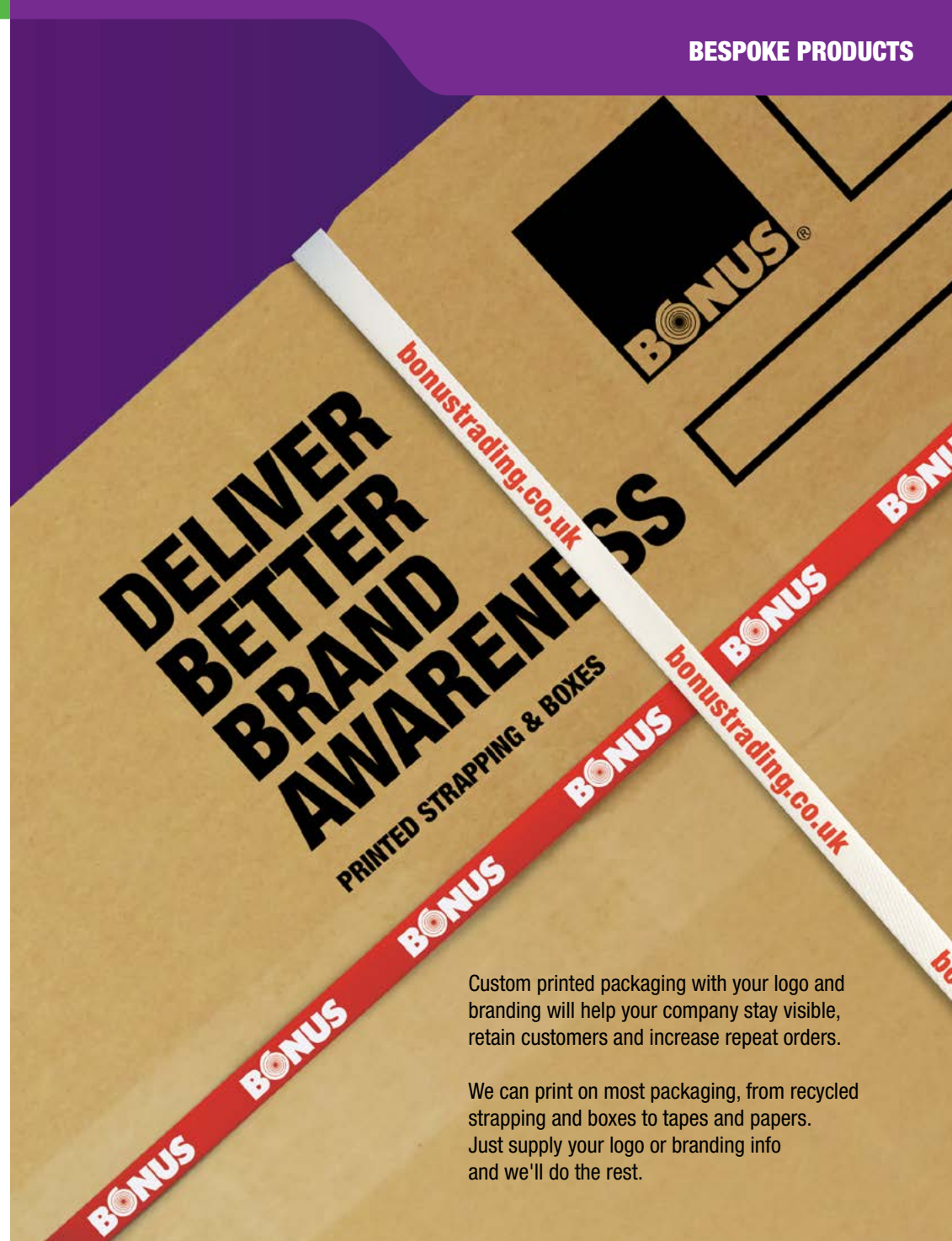

Custom printed packaging with your logo and branding will help your company stay visible, retain customers and increase repeat orders.

We can print on most packaging, from recycled strapping and boxes to tapes and papers. Just supply your logo or branding info and we'll do the rest.

### Mill Wound Strapping Trolley

- Separate tote for seals and tools
  - 13-16mm strap width adjustment
- Strapping and seals not included*



Item Code	Description	Weight
1316004	Mill Wound Strap Trolley	24kg

### Ribbon Wound Strapping Trolley

- Separate plastic tote for seals and tools
  - 19-32mm strap width adjustment
- Strapping and seals not included*



Item Code	Description	Weight
1316011	Ribbon Wound Strap Trolley	16.4kg

### Polyprop Strapping Trolley

- For polyester and polypropylene strapping
  - Compatible with strapping on plastic reels
  - Integral tote holder for holding seals
- Strapping and seals not included*



Item Code	Description	Weight
1316007	Polypropylene Strap Trolley	6.3kg

### Pallet Probe

- Ideal for feeding strapping under pallets
- Suitable for polyprop, polyester & steel strapping
- 1.4m long, 19mm wide



Item Code	Description	Length	Unit
7016021	Pallet probe	1400mm	Each

### Tensioner/Sealer Kit with Dispenser

- Kit contents:  
 Dispenser (1316009); Std Tensioner 7016040  
 12mm Sealer (7016034); 1500m coil of 12mm  
 black strapping (5116010); 500 seals (5916054)



Item Code	Description	Weight
6116020	Polypropylene Strap Trolley	6.3kg

### Tensioner/Sealer Kit with Trolley

- Kit contents:  
 Trolley (1316007); Std Tensioner (7016040)  
 & 12mm Sealer (7016034); 1500m coil of 12mm  
 black strapping (5116010); 500 seals (5916054)



Item Code	Description
6116017	Tensioner/Sealer Kit

### Combi Strapping Kit with Trolley

- Kit contents:  
 Trolley (1316007); Combination Tool (7016030)  
 1500m coil of 12mm black strapping (5116010);  
 500 seals (5916054)



Item Code	Description	Weight
6116018	Polypropylene Strap Trolley	6.3kg

### Stainless Steel Tensioner

- High quality tensioning tool for stainless steel strapping
- For use with 12mm and 19mm strapping band



Item Code	Strap Width	Weight
7016043	12mm and 19mm	1.4kg

### HD Polypropylene Tensioner

- Maximum strap width 19mm
- Good for high strap tension
- Weight 2.2kg



Item Code	Strap Width	Model	Weight
7016036	19mm	HPT	2.2kg

### Std Polypropylene Tensioner

- General use tensioner; strapping up to 19mm
- Designed for use with semi-open or closed metal seals



Item Code	Strap Width	Model	Weight
7016040	19mm	TST30	1.3kg

### Std Polypropylene Strap Sealer

- Single notch action releases highly tensioned strap more easily
- Used on semi-open seals



Item Code	Strap Width	Model	Weight
7016034	12mm	SGP12	2.2kg
7016035	16mm	SGP16	2.2kg

### Medium Polypropylene Strap Sealer

- For strapping small cartons, crates and packages
- Designed for use with semi-open or closed metal seals
- Offset jaws for use on serrated seals



Item Code	Strap Width	Model	Weight
7016014	12mm	KNS12	2.0kg
7016015	16mm	KNS16	2.0kg

### Lightweight Polyprop Combi Tool

- For use with serrated seals:  
12mm - 5916047  
16mm - 5916048



Item Code	Strap Width	Model	Weight
7016028	12mm	RSK12	4.7kg
7016029	16mm	RSK16	4.8kg

### Std Polypropylene Combi Tool

- For use with semi-open seals:  
12mm - 5916054  
16mm - 5916052



See strapping seals on page 78

Item Code	Strap Width	Model	Weight
7016030	12mm	SPC12	3.4kg
7016031	16mm	SPC16	3.5kg

### Battery Powered Strapping Tool



Ask us for a demo. On-site or online

Item Code	Description
7016006	Spare Battery 18V
7016007	Battery Charger

- Friction weld tool
- 18V Li-ion battery included
- Digital touch panel
- Brushless DC motor technology
- Battery and charger included
- Simple adjustment for different size strapping
- Advanced friction weld sealing technology
- Impact resistant robust housing
- Perfect balance & ergonomic design

Item Code	Strap Width	Weight
7016108	11-13mm	4.3kg
7016109	15-16mm	4.3kg
7016111	16-19mm	4.4kg

# OUR SERVICES

In addition to our vast product range and bespoke manufacturing, we provide a range of services to help efficiently manage your packaging stock and supply



## Account Management

Our team of dedicated Account Managers have in-depth experience of our full product range and the bespoke requirements of our customers.

They will be able to assist with any enquiry you may have, offering expert advice and the best solutions for all your packaging needs.



## Inventory Management

We specialise in the storage and distribution of packaging, labels and supplies to our clients, making sure the flow of products from our 30,000 sq. ft. of warehouse space arrive on time, when you need them. Inventory management is a fundamental part of a thriving business.

We can procure, stock hold, and organise the logistics for all of your packaging needs.



## Packaging Assessment

If you are looking for the correct packaging to fit your products we can help you.

We have the experience and capability, and we are always looking for new and innovative ways to package and process the array of products our customers deliver.

The better and more efficiently your goods are packaged, wrapped and protected, the more you can add to your bottom line.

## Pallet Wrap Film Audit

Ask us about our free, no-obligation, pallet wrap film audit. We can visit you to carry out comparison tests, show you where improvements can be made to your process and choice of film, reducing your film usage and minimising plastic waste.

You could make huge gains with high yield films, bringing down usage by 50% without any loss of performance, resulting in cost savings and reducing your carbon footprint.



- Wrap comparison tests
- Full report and analysis
- Recommendations and advice
- Projected savings in costs and time
- Reduction in plastic waste
- Reducing your carbon footprint



## Maintenance, Servicing & Repair

We can maintain the smooth running of your packaging and labelling machinery and equipment. We'll also carry out essential repairs, with fast call out, to ensure you get up and running again quickly.



Some of the equipment we support:

- Taping machines
- Label printing machines
- Pallet wrapping machinery
- Strapping machines and equipment
- Gas guns
- ...and more!



## MACHINE FINANCE PAYMENT PLANS

See more info on page 15

Take delivery of a new machine now. Ask us about finance options.



# FREE GIFTS

Choose a free gift when you place your order online



	Order value		Order value
A7 Post-it Pad	£50	Bonus Beanie Hat	£275
Bonus Eco Pen	£75	Bonus Eco Notebook and Pen	£300
Desk Pad	£75	Bottle of Wine	£350
Dairy Milk Bar 100g	£100	Bonus 6 Panel Football (size 5)	£400
Toblerone 100g	£100	Bonus Thermal Mug	£450
Ice Scraper (recycled & recyclable)	£100	Bonus Rugby Ball	£600
Tin of Shortbread Biscuits	£150	Bluetooth Speaker	£650
Box of Chocolates	£250	£10 High Street Voucher	£800
Bonus Wilton China Tea Mug	£250	Bluetooth Earbuds	£850
Sports Bottle	£275	Soft Shell Jacket (Black)	£950
		Soft Shell Jacket (Navy)	£950

Order values as of printing. Order value excludes VAT. Gifts are subject to availability.

# MEASUREMENTS AND TERMS EXPLAINED

**Acronyms & Terms** The meanings for some commonly used acronyms and terms.

TERM	MEANING
"	Inches - eg. 10" means a measurement of 10 inches
'	Feet - eg. 10' means a measurement of 10 feet
mu	Micron - Often refers to a material thickness such as plastic film
G	Gauge - Often refers to a material thickness such as plastic film
GSM	Grams per Square Metre - A measurement of paper and card weight/thickness
PPS	Power Pre-Stretch - Pallet wrap film can be PPS, as can a pallet wrapping machine with PPS capability

## Comparison Charts

KG	LB
5	11
10	22

PALLET SIZE	MM
Standard Pallet	1200 x 1000
Euro/Europa Pallet	1200 x 800

MM	INCHES
50	1.97
100	3.94
200	7.87
300	11.81
400	15.75
500	19.69
1000	39.37
1500	59.05
2000	78.75

MICRON	GAUGE
5	20
6	24
9	35
15	60
17	67
25	100
40	160
50	200
100	400

PAPER SIZE	MM
A8	52 x 74
A7	74 x 105
A6	105 x 148
A5	148 x 210
A4	210 x 297
A3	297 x 420
A2	420 x 594
A1	594 x 841
A0	841 x 1188

ENVELOPE	MM
C7	84 x 114
C6	114 x 162
C5	162 x 229
C4	324 x 229
C3	458 x 324
DL	110 x 220

**Need help choosing the best packaging solutions for your goods?**

Contact us to discuss your options.

We can send free samples and carry out on-site or online product demos.

## BONUS PACKAGING ASSESSMENT



See detailed insights in to your packaging a processes. Discover where time and costs can be saved. **Contact us to arrange a visit.**



# Optimus® Wrap

Save **50%\***  
with Optimus® films

- High performance wrap
- High yield film
- Reduce costs
- Reduce plastic waste
- Wrap more pallets per roll
- Less machine downtime

**New!**



See films on page 16

## Book a Pallet Wrap Audit

With a free, no-obligation pallet wrap film audit, we will carry out comparison tests and provide a full report about your usage and costs. We often show that...

- Thicker film doesn't always mean stronger
- More wrap layers isn't always better
- Cheaper roll prices may not be lower cost



Regular pallet wrap film

**Optimus**

Contact us to arrange a film audit

\* Average saving is 50%. Savings can range from 40-60%.



**Bonus Trading**  
 ☎ 08000 540 100  
 ✉ sales@bonustrading.co.uk  
**bonustrading.co.uk**



Trading House, Harvard Industrial Estate, Kimbolton PE28 0NJ  
 Carlton House, 34-36 Carlton Park Industrial Estate, Saxmundham IP17 2NL  
 Bonus Trading UK Limited. Registered in England No. 8151258. VAT Registration No. GB 847 1197 10

Call Free **08000 540 100** ...or online at **bonustrading.co.uk**